

menus:

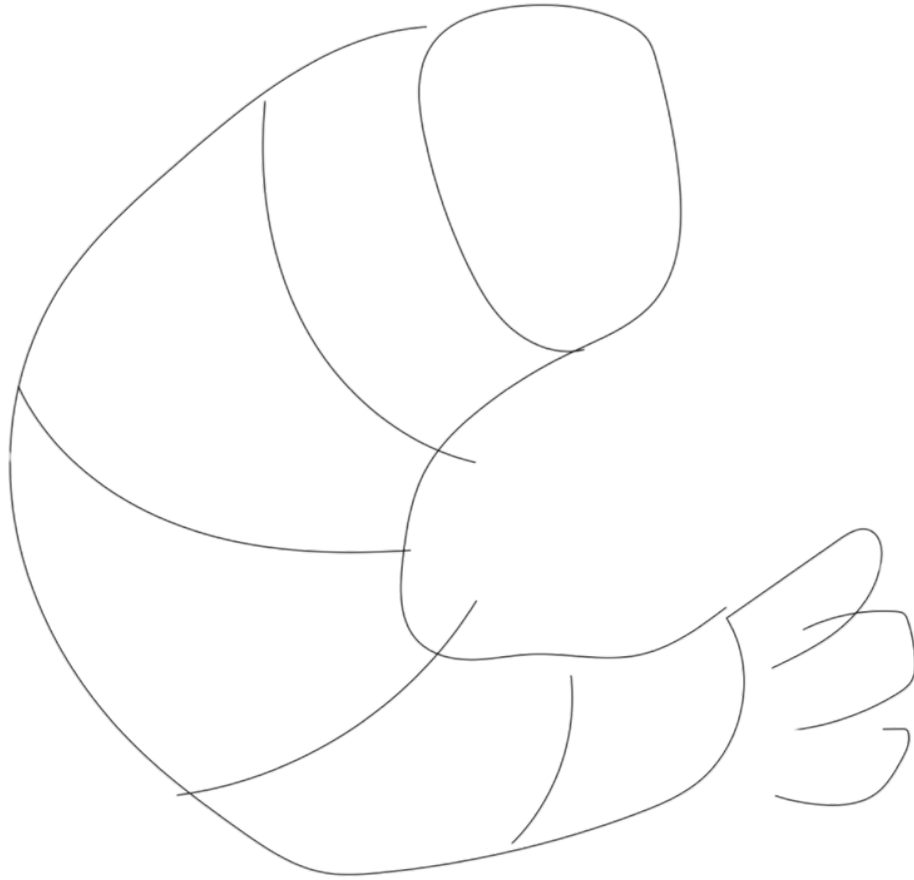

t

welcome to trobar
the place where:

The eternal seekers go crazy when the perfect song comes up in the perfect place, at the perfect time. They become soulmates by just saying 'I love the way you think'. They collect art because of the impact on their lives, not their pockets. They save all the umami experiences in the most intricate corners of the mind. And collect all that makes life worth living day after day, time and time again. That's why they always come back here; to find everything they once found. Just like you do.

r

back
to
find,
trobar

trobar kitchen

antipasti

focaccia al rosmarino / focaccia with rosemary €3.5 p.p V VGN
ARTIST: CONSTANZA CECCHETTO

olive marinate mediterranee / mediterranean marinated olives €5 V VGN GF
ARTIST: CONSTANZA CECCHETTO

parmigiano / parmesan cheese chunks €8 V GF
ARTIST: ANNA DEMIDOVA

peperoni marinati / marinated capsicum €6 V VGN GF
ARTIST: ANNA DEMIDOVA

caponata / caponata €8 V GF
ARTIST: BIEL MIRALLES

schacciata di zucchine alla maiorchina / zucchini sicilian flatbread "mallorquin" style €8 V VGN GF
ARTIST: ALFONSO REYES

caprese 2.0, reimmaginata / caprese 2.0, reimagined €9 V GF
ARTIST: MARTINE THOELLEN

sarde in marinata al trobar / sardines in trobar marinade €10 GF
ARTIST: ALFONSO REYES

insalata di stagione / seasonal salad €8 V VGN GF
ARTIST: HANNAH SIMPSON

burrata, a modo nostro / burrata, our way €12 V GF
ARTIST: LAURA RUBIO BANON

arancini al ragù / ragu arancini €4.5 ea
ARTIST: CONSTANZA CARRASCO

involtini di manzo / beef rolls €10
ARTIST: ALFONSO REYES

vitello tonnato / veal with tuna sauce €14 GF
ARTIST: CONSTANZA CARRASCO

polpette / meatballs €14 GF
ARTIST: CONSTANZA CECCHETTO

calamari ripieni / stuffed calamari €16
ARTIST: ALFONSO REYES

parmigiana di melanzane / eggplant parmigiana €10 V GF
ARTIST: TROBAT CASA

lasagne ragu / lasagne bolognese €14
ARTIST: TERESA MONMAS

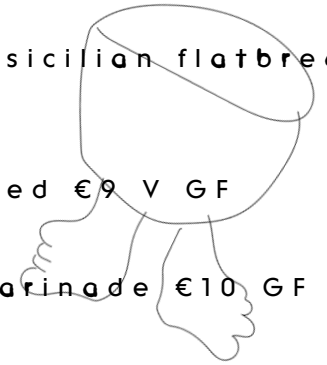

buon appetito!

V = vegetarian VGN = vegan GF = gluten free
If you have any allergies, please advise us.



dolci

palline di tiramisù / tiramisu ball €2 ea

ARTIST: MISTER PIRO

biscotti di mandorle / almond biscuit with cherry €2 ea

ARTIST: MISTER PIRO

cannoli / cannoli €2.5 ea

ARTIST: MISTER PIRO

brioche con gelato di limone / brioche with lemon gelato €6

ARTIST: CONSTANZA CECCHETTO

semifreddo con noci croccanti tostate / semifreddo with

toasted crunchy nuts €6.5 GF

ARTIST: CONSTANZA CECCHETTO

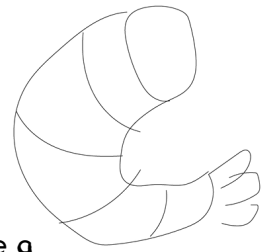

trobat.co was established as an online marketplace to showcase and sell the work of over 35 emerging artists from around the world — a curated collection of original artworks that celebrates talent, craft, and creative expression. our online store was established in 2021 and ships worldwide. From that foundation, **trobar** was born — our physical, conceptual space to experience these pieces in person and step into the world we've created. The space itself was interior designed in collaboration with our founder and **trobat.co** artists along with all our tableware. In Catalan, **trobat** means "found," representing the treasures we've discovered and brought together online; while **trobar** means "to find" — the act of seeking, of connecting, of uncovering beauty. It's the place you have come to find and experience what we've already found for you.

By shopping with us, you're directly supporting handcrafted art from creative, up and coming artisans around the globe.

tablescape

plates by Constanza Company

utensils by Sebastião Lobo

napkins by trobar

wine glasses by trobar

candelabras by Rubble Workshop

coasters by Biel Miralles

water glasses by trobar

salt bowls by trobat casa

coffee cups by Teresa Monmas

all our tableware has its own unique story. pieces are either created by trobat artists in collaboration with trobar, are vintage items from our retrobat line, are eclectic pieces collected by our curator from our objecte trobat range, or they are made by us and are part of our trobat casa collection. scan to shop all that you see and more.



@trobat.co



@trobar_





t

r

txin txin!

signature cocktails from trobar — created by Luis Aguayo

our exclusive cocktail collection is crafted with house made ingredients and premium liquors, served in distinctive artisan glassware, a reflection of our commitment to creativity, quality, and zero waste. all our “glassware” is either created by trobat artists in collaboration with trobar, are vintage items from our retrobat line, are eclectic pieces collected by our curator from our objecte trobat range, or they are made by us and are part of our trobat casa collection.

all are available for purchase at www.trobat.co/trobar

follow us @trobat.co @trobar_

the artist

it's not just a drink, it's a lifestyle choice

(ingredients):

vodka, orange liqueur, lime, blackberry & hibiscus

artist: Laura Rubio Bañón

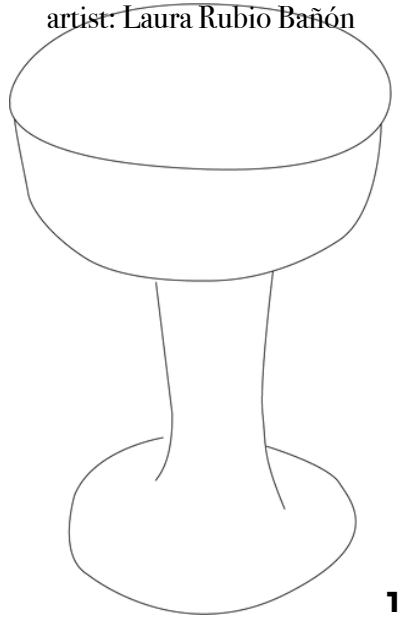

13€

get caught in the rain

sometimes getting wet is part of the plan

(ingredients):

coconut rum, pineapple, lime, toasted coconut & cinnamon

artist: trobar

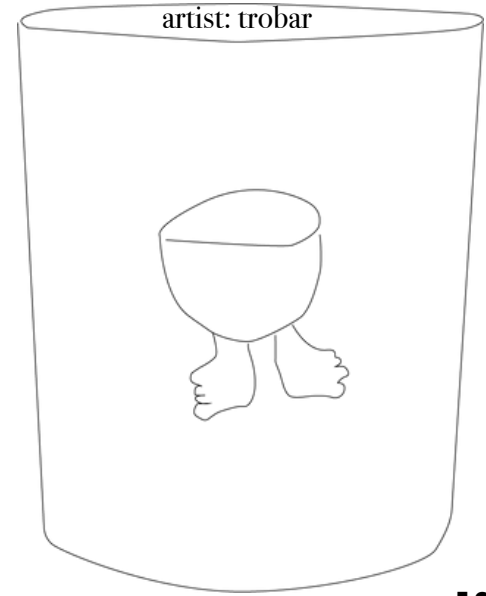

13,5€

green smoke

you're now in the alarm-free zone

(ingredients):

gin, mezcal, cucumber, lemon, mint, ginger & cardamom

artist: Hannah Simpson

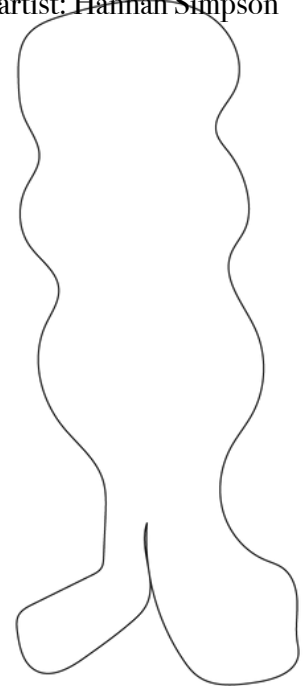

14€

spicy dahlia

where flowers flirt and chilli's sting

(ingredients):

reposado tequila, orange & chipotle liqueur, lime & agave

artist: trobat casa

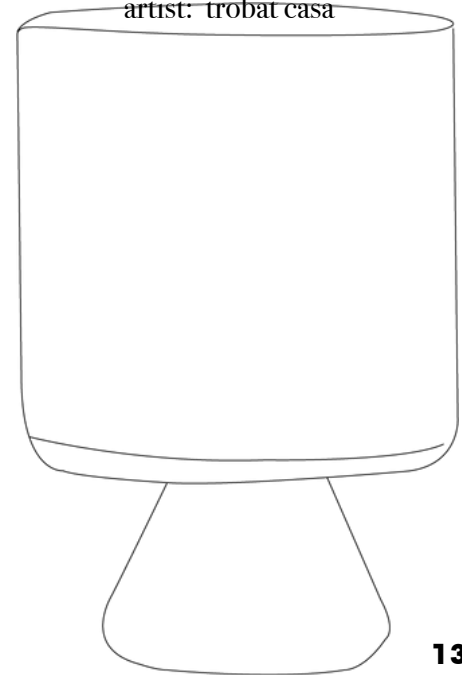

13,5€

born in milan

mary went to Italy,
she never texted back

(ingredients):

parmesan vodka, house made
limoncello, tomato, grapefruit & basil

artist: Teresa Monmas

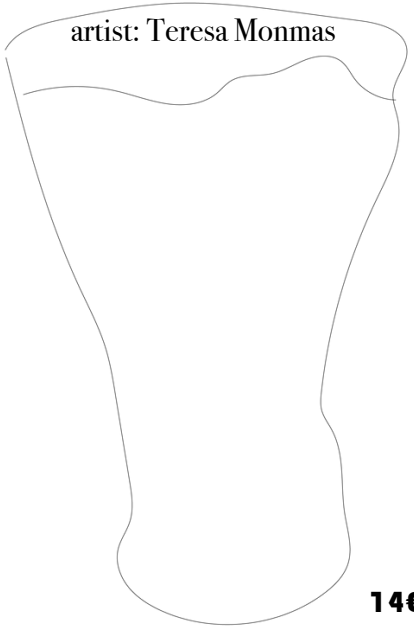

14€

but first, coffee

let's handle one crisis at a time

(ingredients):

vodka, coffee liqueur, cold brew
espresso & vanilla

artist: Laura Rubio Banon

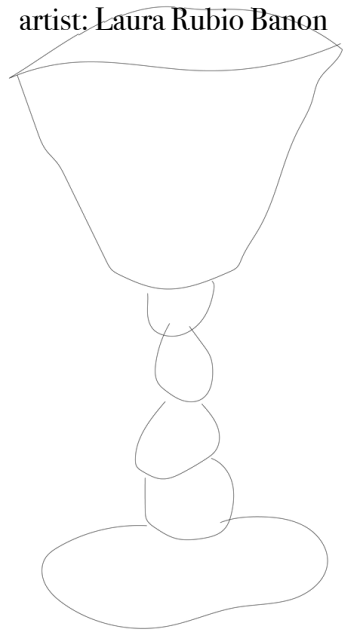

13,5€

matcha la vista

after all that sea, we landed on sorbet

(ingredients):

vodka, apple brandy, lime, mint,
house made matcha & yuzu sorbet

artist: Justine Menard

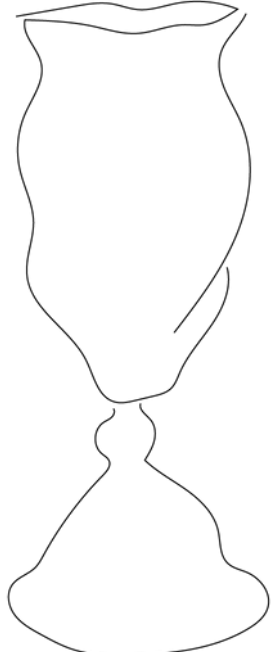

14€

purple & tonic

when a g&t just won't cut it

(ingredients):

thai flower infused gin, elderflower liqueur,
lemon, lavender topped with
mediterranean tonic

artist: trobar

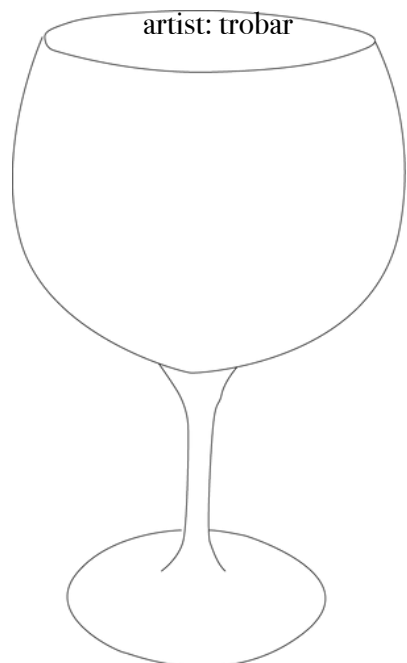

13€

la concha

your new guilty pleasure, washed ashore

(ingredients):

12 years scotch whiskey, kiwi, lemon, chamomile & lemongrass

artist: Constanza Cecchetto & objecte trobat,

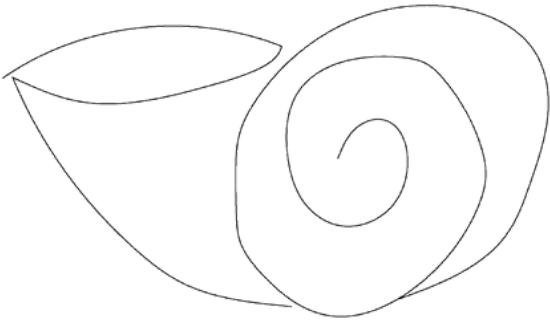

15€

mangoco

you'll be loco for it

(ingredients):

dark rum, mango chutney, orange, lime & toasted coconut

artist: Hannah Simpson

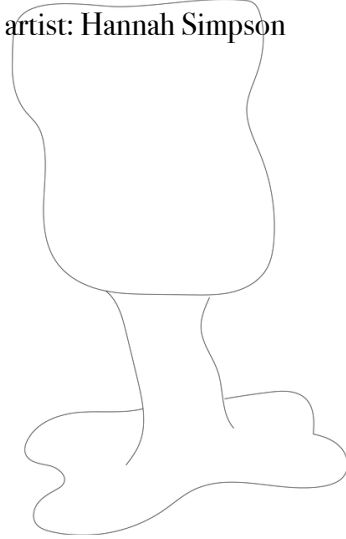

13,5€

sakxy nikkei

Peru meets Japan, passion sparks and flavours dance

(ingredients):

sake, pisco, passion fruit, lime & vanilla

artist: Hannah Simpson

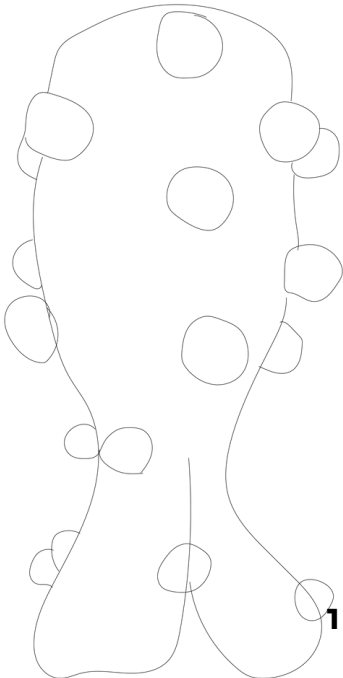

14€

tiny disco

like a party in a glass

(ingredients):

mezcal, strawberry, pineapple, grapefruit, lime & house made pomelo soda

artist: Martine Thoelen

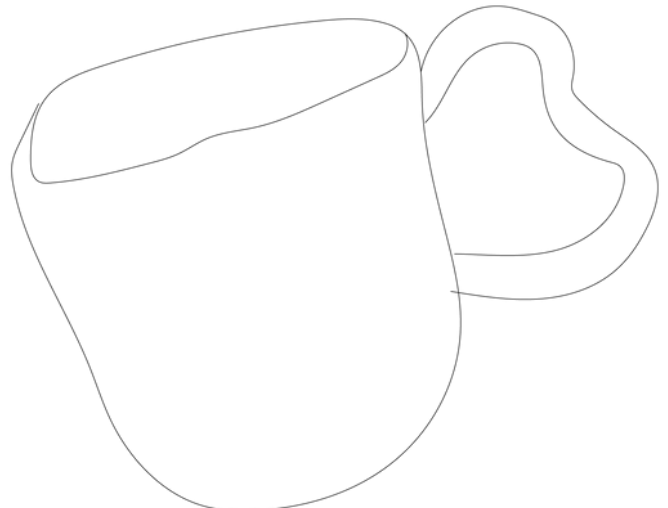

14.5€

ace of hearts

don't bluff, we have the winning hand

(ingredients):

gin, white vermouth, lemon,
raspberry & rose

artist: Justine Menard

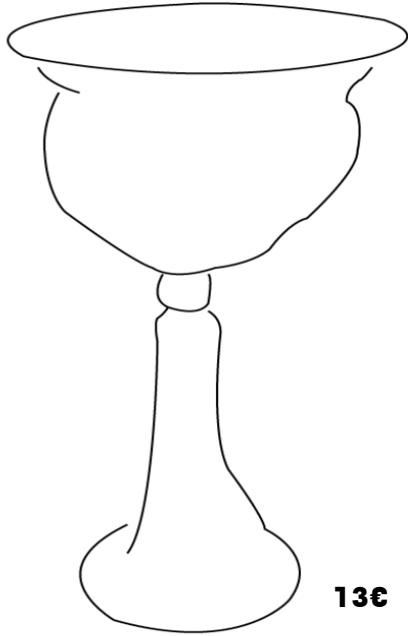

13€

muy-tasty

starts with a shake, ends with a purr

(ingredients):

mix of rums, orange liqueur,
lime & spiced pineapple

artist: Alfonso Reyes

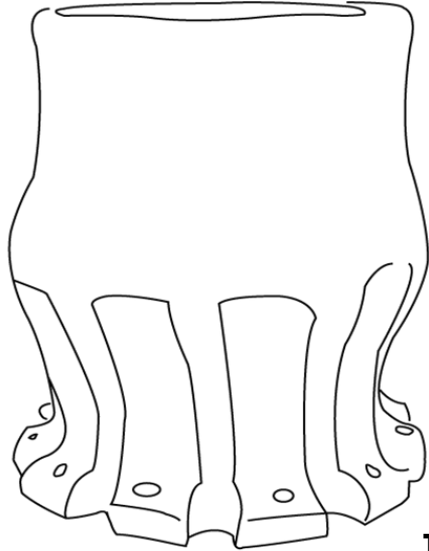

13.5€

say no more

let the flavour do the talking

(ingredients):

whiskey, amaretto liqueur, lemon,
orange & cherry

artist: Anna Demidova

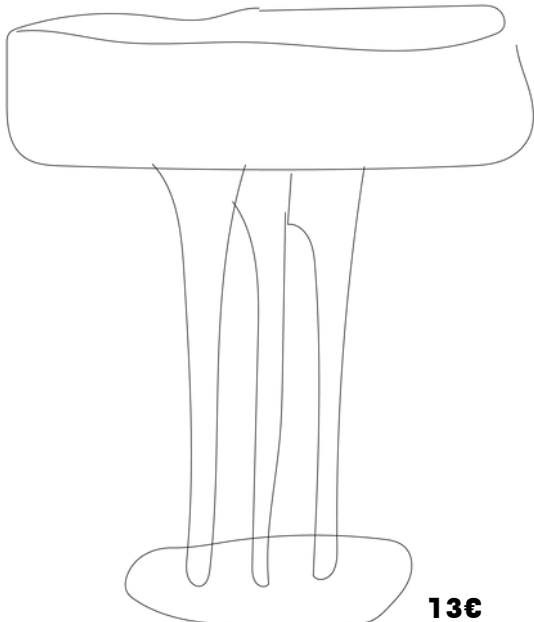

13€

x-rated martini

blurred lines and bad decisions

(ingredients):

vodka, elderflower liqueur,
passion fruit, lemon, raspberry & rose

artist: Anna Demidova

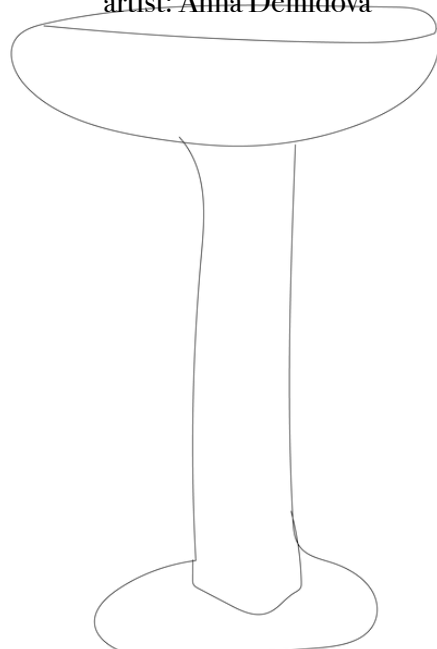

14€

slap da basil

botanicals behaving badly (and we love it)

(Ingredients):

gin, herbal liqueur, lime & basil topped with Indian tonic

artist: trobar

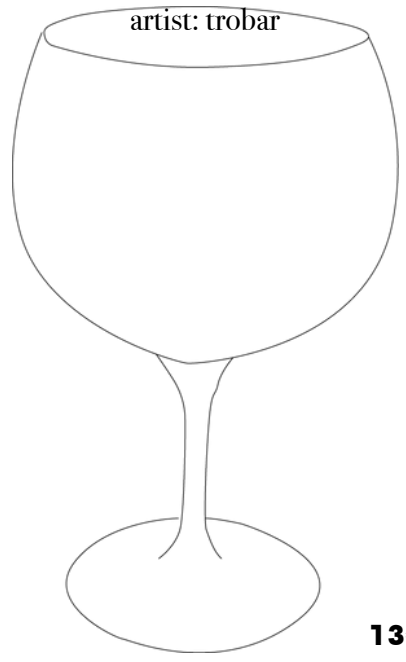

13€

mexican blood

a road trip from Oaxaca to Jalisco

(ingredients):

achiote tequila, corn liqueur, tomato & lime topped with corona beer

artist: Teresa Monmas

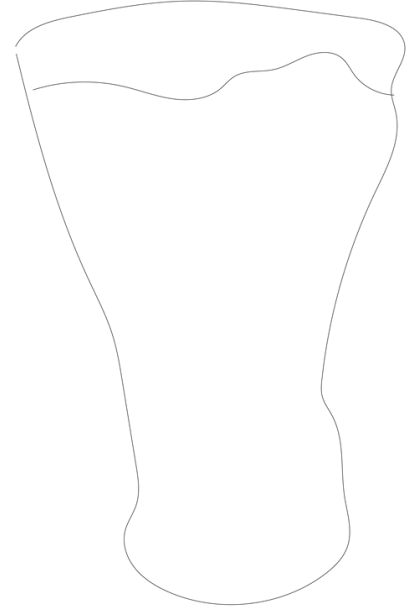

14€

okita e bossa

delicate like origami, wild like carnival

(ingredients):

cachaça, melon liqueur, apple, lime, ginger & cardamom with a hint of wasabi

artist: Anna Demidova

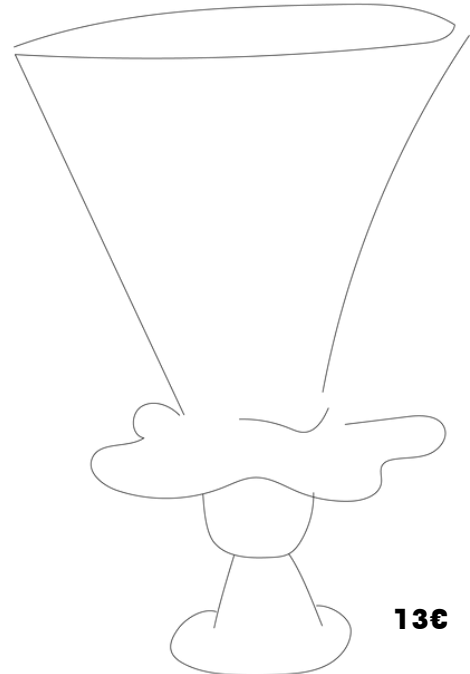

13€

sol & sip

spain in a glass

(ingredients):

red or sparkling wine, secret liquor blend, grapefruit, orange, peach & watermelon

artist: trobar

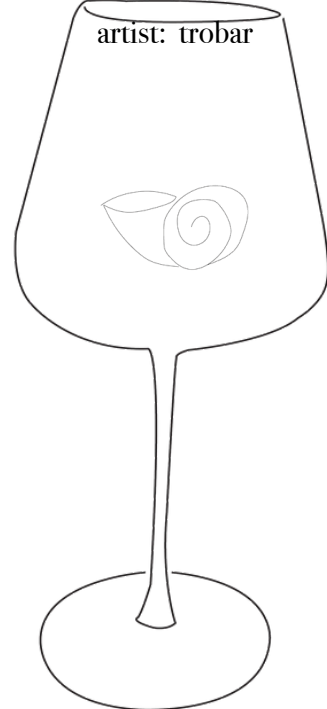

13€

amore al amaro

bitter like your ex, but way more fun

(ingredients):

gin, amaro, sweet vermouth,
bitter orange liqueur & cava

artist: trobat casa

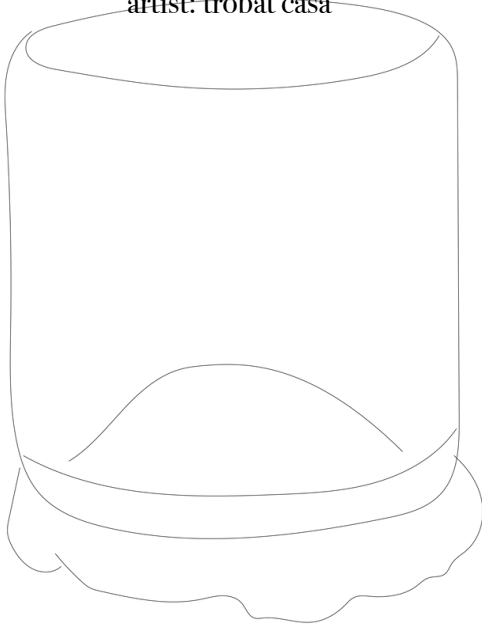

13€

pinky promise

one sip and your lips are sealed,
mostly...

(ingredients):

silver tequila, lime topped with
house made grapefruit soda

artist: trobar

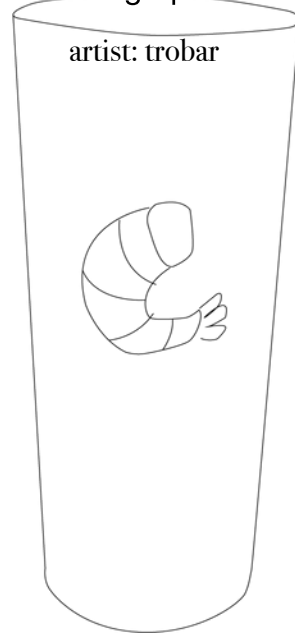

13€

tea is my calling

it's five o'clock somewhere

(ingredients):

gin, black ice tea, peach, lemon & mint

artist: Anna Demidova

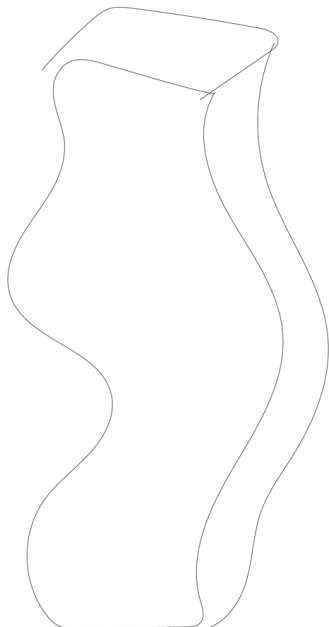

13.5€

pinch & a punch

rum's not invited,
only smoky VIPs allowed

(ingredients):

whisky, mezcal, lime & spiced
pineapple

artist: Laura Rubio Bañón

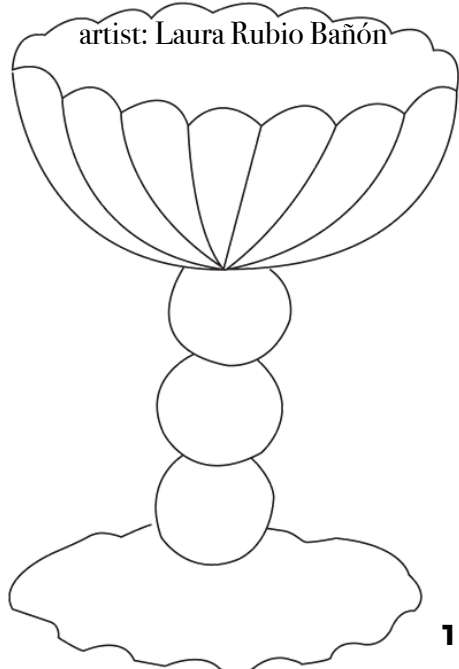

14€

{ spritz time! }

soller spritz **13€**
orange liqueur, sparkling wine, grapefruit & soda

donghi's spritz **13€**
house made limoncello, sparkling wine, lime & soda

venice spritz **12€**
italian bittersweet liqueur, sparkling wine, orange & soda

boss spritz **14€**
elderflower liqueur, sparkling wine, mint, lemon & soda

long drinks, our way

made with premium spirits, homemade or local artisan sodas - all €12

the cuban
rum & cola

sunset with friends
reposado tequila & orange soda

lemon-aid
vodka & lemon soda

brazillian soul
cachaça & grapefruit soda

french kiss
brandy & apple juice

harakiri
mezcal & chilli tonic

mare nostrum
gin & mediterranean tonic

the outlaw
scotch whiskey & ginger ale

digestives

Donghi's limoncello **6€**

when life gives you lemons... make limoncello, not lemonade. our limoncello is a long standing family recipe from our Italian co-owner. trust us, one is never enough.

booze free zone

not drinking tonight? we've got you. explore our selection of delicious mocktails, all sans alcohol.

easy peasy

keep it breezy

(ingredients):

non-alcoholic mezcal, strawberry, pineapple, grapefruit & lime

artist: Martine Thoelen

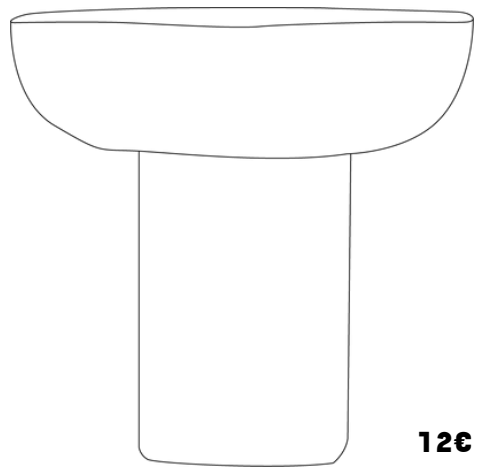

12€

pachamama

less waste, more taste

(ingredients):

non-alcoholic tequila, orange, mango chutney, lime & vanilla

artist: Hannah Simpson

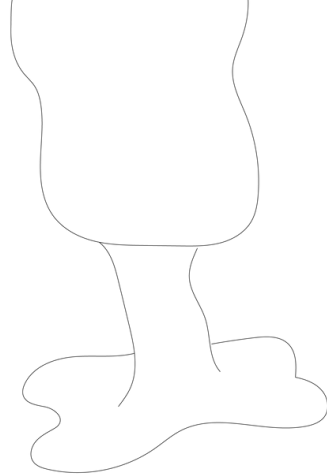

12€

t

apple of my eye

like your crush without the fuss

(ingredients):

non-alcoholic vodka, apple, lemon, mint, ginger & cardamom

artist: trobat casa

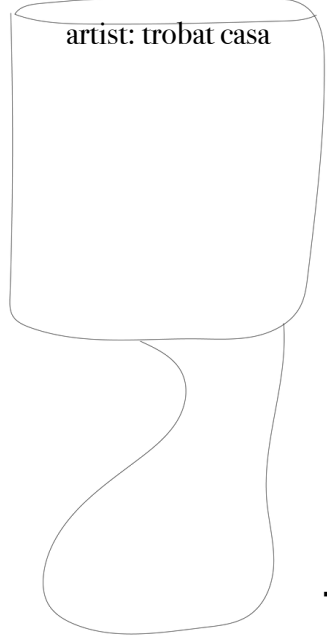

12€

bitter blossom

all the zest, none of the mess

(ingredients):

zero sparkling wine, non-alcoholic bitter orange liqueur & grapefruit

artist: trobar



12€

r

nutty by nature

almond charm, zero harm

(ingredients):

non-alcoholic amaretto & whiskey, orange, lemon & spiced pineapple

artist: trobat casa

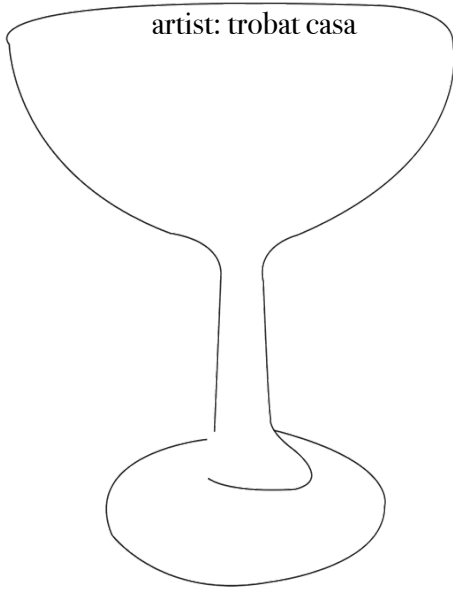

12€

midnight velvet

party late, wake up great

(ingredients):

non-alcoholic coffee liqueur & dark rum, cold brew espresso & toasted coconut

artist: Laura Rubio Banon

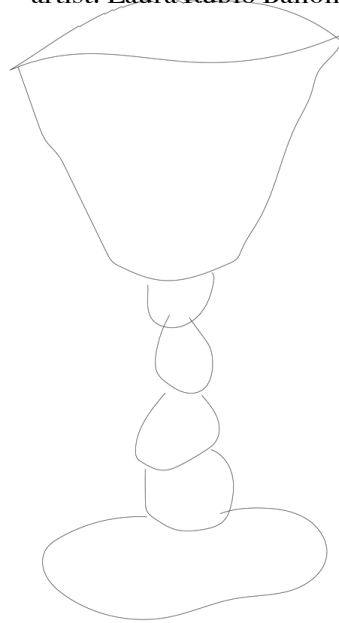

12€

citrus affair

the only love triangle you need

(ingredients):

non-alcoholic white rum, passion fruit, lime, kiwi, lemongrass & chamomile

artist: Teresa Monmas

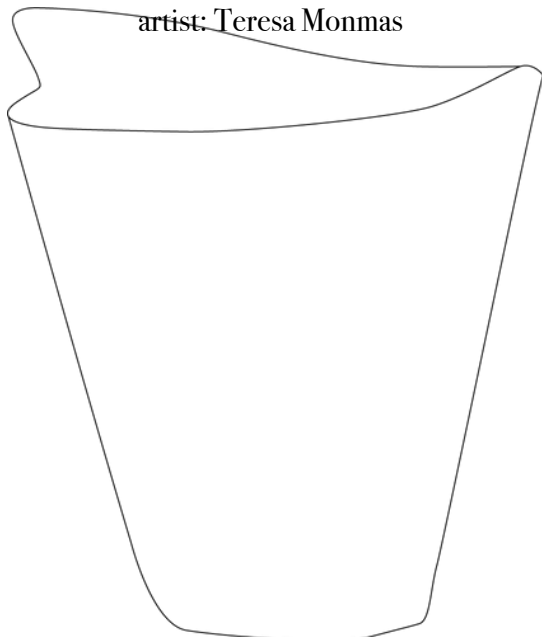

12€

see who's to blame

smile, flirt, point fingers... wanna play?

(ingredients):

non-alcoholic gin, cucumber, orange, peach, blackberry & hibiscus

artist: trobat casa

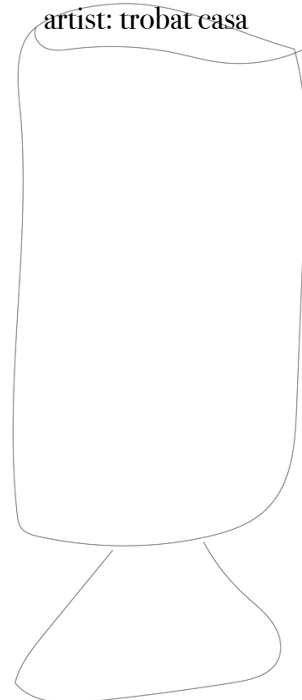

12€

sodas & tea

black iced tea
trobar ginger ale soda
trobar grapefruit soda
puig cola (Mallorca)
puig cola zero (Mallorca)
puig lemon soda (Mallorca)
puig orange soda (Mallorca) **3.5€**

fresh juice

apple
pineapple
orange
peach **4.5€**

water

still (500ml): **2,5€** (1L): **3,5€** sparkling (500ml): **3€** (1L): **4€**

beer

not a cocktail person? we can't relate but we respect it. explore our curated selection of wines and beer instead.

peroni **5€**
coronita **4,5€**
beer lovers Mallorca broil (a classic craft beer) **6,5€**
beer lovers Mallorca dipa (double india pale ale) **6,5€**

portuguese hard kombucha

glass:

ummi kombucha - mango tumeric **6€**
ummi kombucha - hibiscus berry **6€**

wine

{ bubbles }

	glass:	bottle:
vinestar ancestral pet nat (Spain)	8€	40€
pertois-moriset les quatre terroirs (France)		100€
ruinart brut (France)		130€

/ white /

	glass:	bottle:
remordiento bodega cerron chardonnay (Spain)	7€	35€
lirondo pet nat (Spain)	7.5€	38€

{ rose }

	glass:	bottle:
mas de canet blanc (Mallorca)	7,5€	38€
s vins clarete (Mallorca) (rose white wine blend)		50€
hada furthmann rasado roshada (Mallorca)		55€

/ red /

	glass:	bottle:
caminando tempranillo (Spain)	7€	35€
gre2 garnacha (Spain)	8€	40€
matas altas (Spain)		50€

wine cont...

orange

s vins p orange (Spain)

bottle:

50€

no alcohol

kolonne null riesling white wine

28€

kolonne null rosé rose

28€

oddbird GSM vino red wine

32€

freixenet 0,0% alcohol free sparkling wine

20€

vermut

cueva negro vermut

glass:

5€

martini riserva rubino

6€

martini riserva ambrato

6€

antica formula

8€

t

r

trobat.co was established as an online marketplace to showcase and sell the work of over 35 emerging artists from around the world— a curated collection of original artworks that celebrates talent, craft, and creative expression. Our online store was established in 2021 and ships worldwide. From that foundation, **trobar** was born our physical, conceptual space to experience these pieces in person and step into the world we've created. The space itself was interior designed in collaboration with our founder and **trobat.co** artists along with all our tableware. In Catalan, **trobat** means "found," representing the treasures we've discovered and brought together online; while **trobar** means "to find" the act of seeking, of connecting, of uncovering beauty. It's the place you have come to find and experience what we've already found for you.

by shopping with us, you're
directly supporting
handcrafted art from
creative, up and coming
artisans around the globe.

t

r

all that you see is available for purchase at www.trobat.co/trobar
follow us @trobat.co @trobar_

*scan to
shop*



@trobat.co

@trobar_

menús

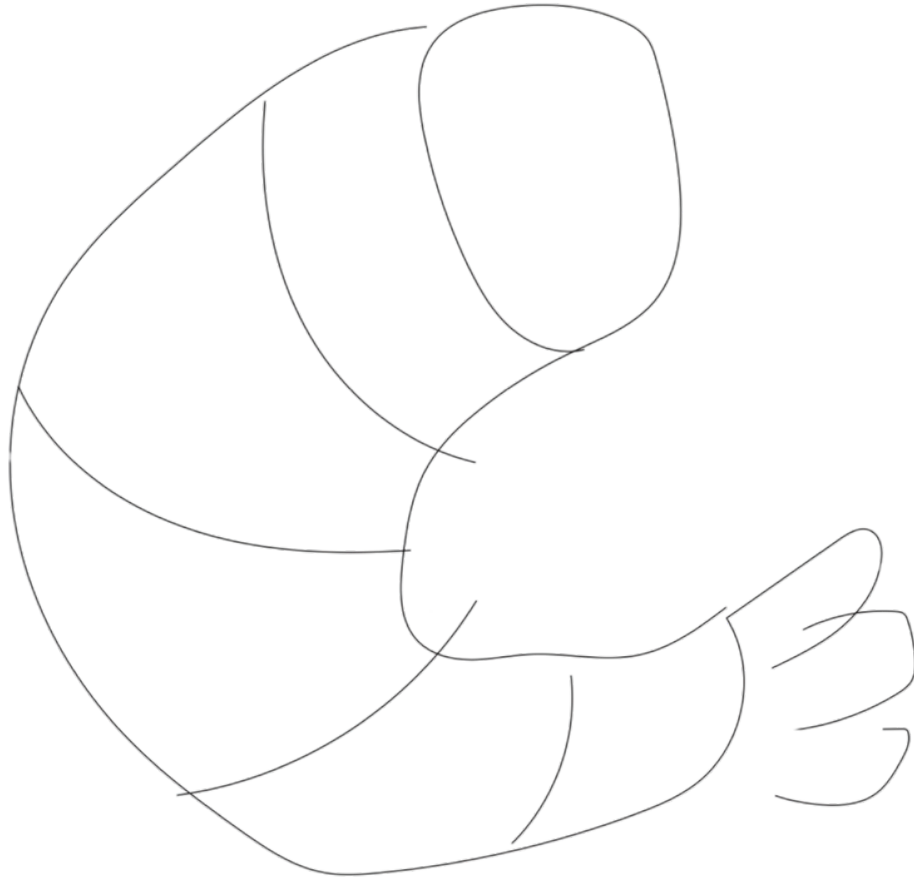

t

welcome to trobar
the place where:

The eternal seekers go crazy when the perfect song comes up in the perfect place, at the perfect time. They become soulmates by just saying 'I love the way you think'. They collect art because of the impact on their lives, not their pockets. They save all the umami experiences in the most intricate corners of the mind. And collect all that makes life worth living day after day, time and time again. That's why they always come back here; to find everything they once found. Just like you do.

r

back
to
find,
trobar

trobar kitchen

antipasti

focaccia al rosmarino / focaccia con romero €3.5 u.d V VGN
ARTISTA: CONSTANZA CECCHETTO

olive marinate mediterranee / aceitunas marinadas estilo mediterráneo €5 V VGN GF
ARTISTA: CONSTANZA CECCHETTO

parmigiano / queso parmesano en trozos €8 V GF
ARTISTA: ANNA DEMIDOVA

peperoni marinati / pimiento marinado €6 V VGN GF
ARTISTA: ANNA DEMIDOVA

caponata / caponata €8 V VGN GF
ARTISTA: BIEL MIRALLES

schacciata di zucchine alla maiorchina / scacciata de calabacín al estio mallorquin €8 V GF
ARTISTA: ALFONSO REYES

caprese 2.0, reimmaginata / caprese 2.0, reimaginada €9 V GF
ARTISTA: MARTINE THOELLEN

sardine in marinata al trobar / boqueron en vinagre estilo trobar €10 GF
ARTISTA: ALFONSO REYES

insalata di stagione / ensalada de temporada €8 V VGN GF
ARTISTA: HANNAH SIMPSON

burrata, a modo nostro / burrata, a nuestra manera €12 V GF
ARTISTA: LAURA RUBIO BANON

arancini al ragù / arancini con ragù €4.5 u.d
ARTISTA: CONSTANZA CARRASCO

involtini di manzo / rollos de carne €10
ARTISTA: ALFONSO REYES

vitello tonnato / ternera con salsa de atún €14 GF
ARTISTA: CONSTANZA CECCHETTO

polpette / albóndigas €14 GF
ARTISTA: CONSTANZA CECCHETTO

calamari ripieni / calamares rellenos €16
ARTISTA: ALFONSO REYES

parmigiana di melanzane / berenjena a la parmesana €10 V GF
ARTISTA: TROBAT CASA

lasagne ragu / lasaña ragú €14
ARTISTA: TERESA MONMAS



buon appetito!

V = vegetariano VGN = vegano GF = sin gluten
si tiene alguna alergia, por favor infórmenos.



dolci

palline di tiramisù / bolas de tiramisú €2 u.d

ARTISTA: MISTER PIRO

biscotti di mandorle / galletas de almendras con cereza €2 u.d

ARTISTA: MISTER PIRO

cannoli / cannoli €2.5 u.d

ARTISTA: MISTER PIRO

brioche con gelato di limone / brioche con helado de limón €6

ARTISTA: CONSTANZA CECCHETTO

semifreddo con noci croccanti tostate / semifrío con crujiente de frutos secos tostados €6.5 GF

ARTISTA: CONSTANZA CECCHETTO



trobat.co se fundó como una plataforma online para exhibir y vender la obra de más de 35 artistas emergentes de todo el mundo: una colección selecta de obras de arte originales que celebra el talento, la artesanía y la expresión creativa. nuestra tienda online se fundó en 2021 y realiza envíos a todo el mundo. de ahí surgió trobar, nuestro espacio físico y conceptual para experimentar estas piezas en persona y sumergirse en el mundo que hemos creado. el espacio, al igual que toda nuestra vajilla, fue diseñado en colaboración con nuestro fundador y los artistas de trobat.co. en catalán, trobat significa "encontrado", representando los tesoros que hemos descubierto y recopilado online; mientras que trobar significa "encontrar": el acto de buscar, conectar, descubrir la belleza. es el lugar al que has venido para descubrir y experimentar lo que ya hemos encontrado para ti. al comprar con nosotros, apoyas directamente el arte artesanal de artesanos creativos y emergentes de todo el mundo.

decoración de mesa

platos de Constanza Company

cubiertos de Sebastião Lobo

servilletas de trobar

copas de vino de trobar

candelabros de Rubble Workshop

posavasos de Biel Miralles

vasos de agua de trobar

cuencos de sal de trobat casa

tazas de café de Teresa Monmas

toda nuestra vajilla tiene su propia historia. las piezas son creadas por artistas de trobat en colaboración con trobar, son artículos vintage de nuestra línea retrobat, son piezas eclécticas recopiladas por nuestro comisario de nuestra gama de objetos trobat, o son elaboradas por nosotros y forman parte de nuestra colección trobat Casa. Escanea para ver todo lo que ves y mucho más.



@trobat.co



@trobar_



menú de bebidas:

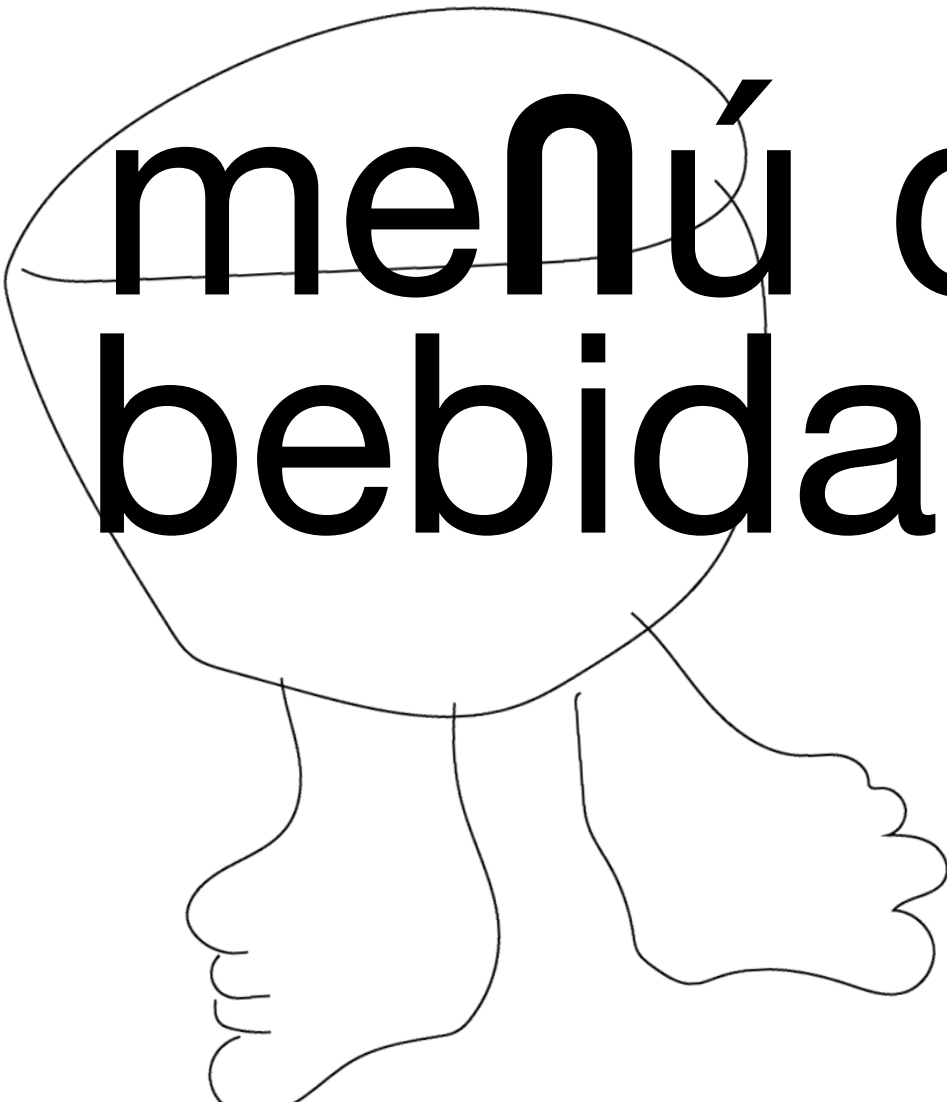

t

r

txin txin!

cócteles de autor trobar — creado por Luis Aguayo

nuestra exclusiva colección de cócteles se elabora con ingredientes caseros y licores de primera calidad, y se sirve en cristalería artesanal distintiva, reflejo de nuestro compromiso con la creatividad, la calidad y el residuo cero.

toda nuestra cristalería está creada por artistas trobat en colaboración con trobar, son piezas vintage de nuestra línea retrobatik, son piezas eclécticas recogidas por nuestro comisario de nuestra gama objecte trobat, o están hechas por nosotros y forman parte de nuestra colección trobat casa.

todas están disponibles en www.trobat.co/trobar

síguenos @trobat.co @trobar_

the artist

no es sólo una bebida,
es un estilo de vida

(ingredientes):

vodka, licor de naranja, lima,
moras y flor de hibisco

artista: Laura Rubio Bañón

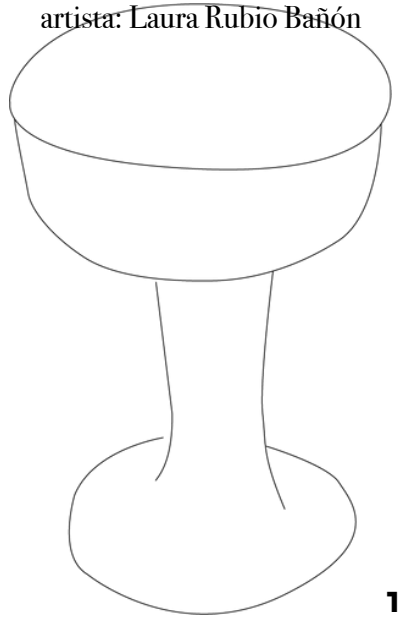

13€

get caught in the rain

a veces mojarse
forma parte del plan

(ingredientes):

ron de coco, piña, lima, coco
tostado y canela rallada

artista: trobar

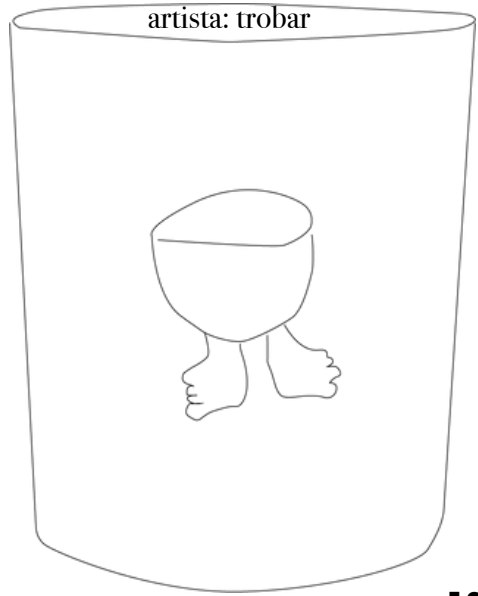

13,5€

green smoke

bienvenid@ a la zona libre de alarmas

(ingredientes):

ginebra, mezcal, pepino, limón, menta,
jengibre y cardamomo

artista: Hannah Simpson

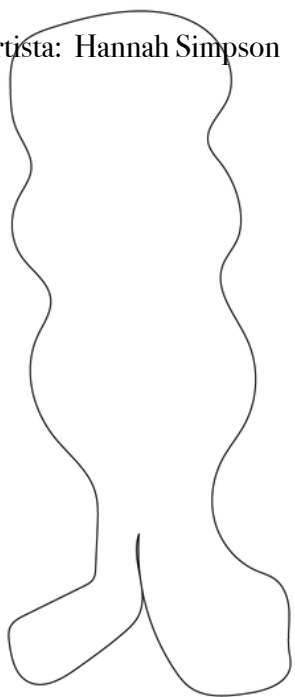

14€

spicy dahlia

donde las flores coquetean
y los chiles se menean

(ingredientes):

tequila reposado, licor de naranja y
chipotle, lima, agave con tajin

artista: trobat casa

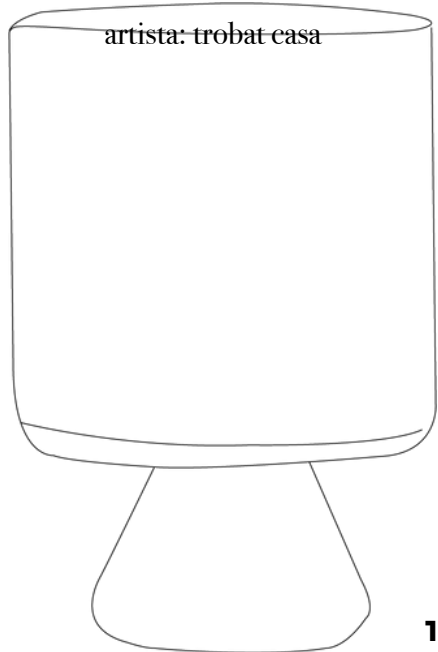

13,5€

born in milan

maria se fue a Italia...
creemos que no va a volver

(ingredientes):

vodka parmesano, limoncello casero,
tomate, pomelo & albahaca

artista: Teresa Monmas

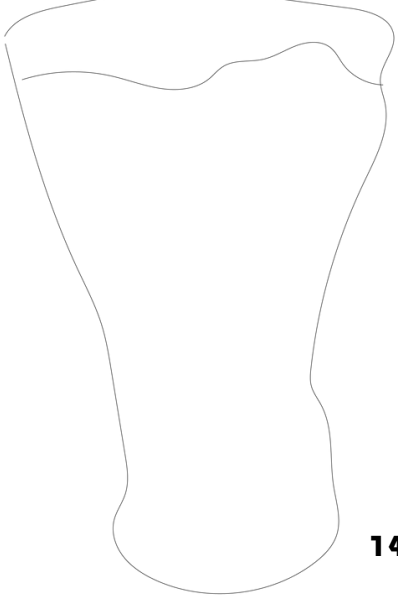

14€

but first, coffee

las crisis mejor de una en una

(ingredientes):

vodka, licor de café, espresso
infusionado en frio & vainilla

artista: Laura Rubio Banon

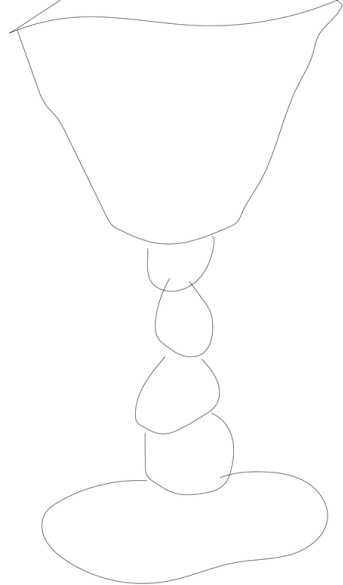

13,5€

matcha la vista

después de tanto mar,
atracamos en sorbete

(ingredientes):

vodka, brandy de manzana, lima, menta,
sorbete casero de matcha y yuzu

artista: Justine Menard

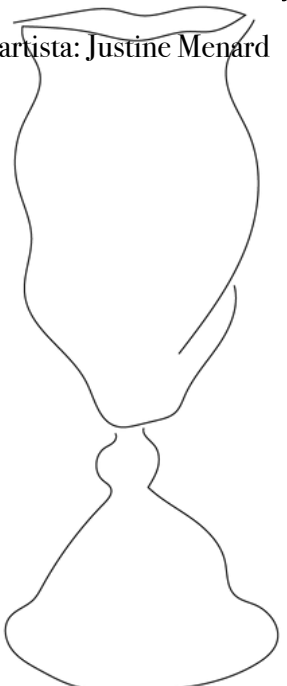

14€

purple & tonic

cuando un g&t no es suficiente

(ingredientes):

ginebra, licor de flor de saúco, limón y
lavanda con tónica mediterránea

artista: trobar

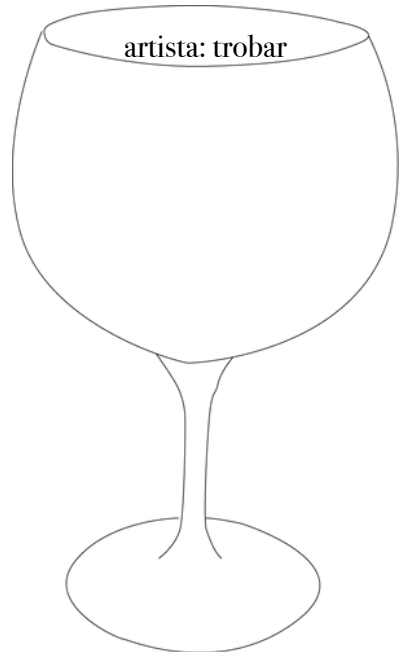

13€

la concha

tu nuevo antojo irresistible,
arrastrado por las mareas

(ingredientes):

whisky escocés de 12 años, kiwi, limón,
manzanilla y hierba limón

artista: Constazna Cecchetto & objecte trobat

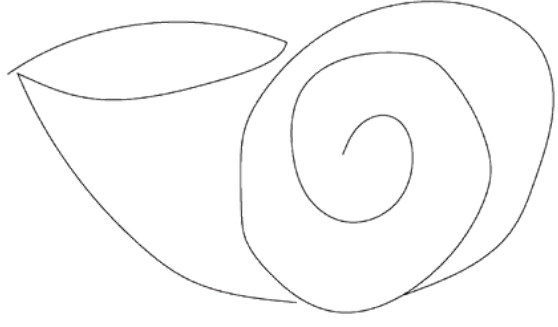

15€

mangoco

te volverá loco

(ingredientes):

ron oscuro, chutney de mango, naranja,
lima y coco tostado

artista: Hannah Simpson

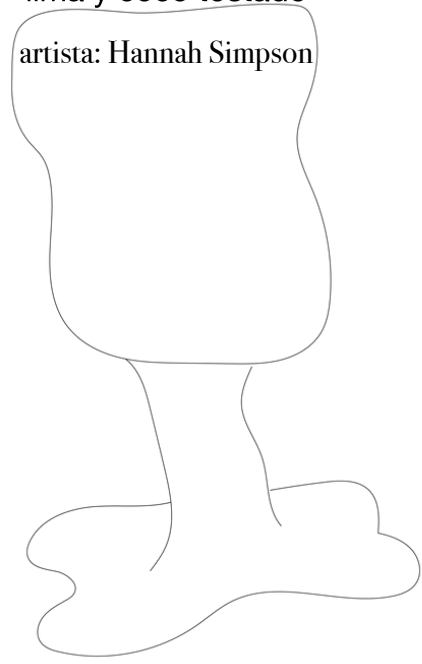

13,5€

sakxy nikkei

perú conoce japon, los sabores bailan
y despierta la pasión

(ingredientes):

sake, pisco, fruta de la pasión,
lima y vainilla

artista: Hannah Simpson

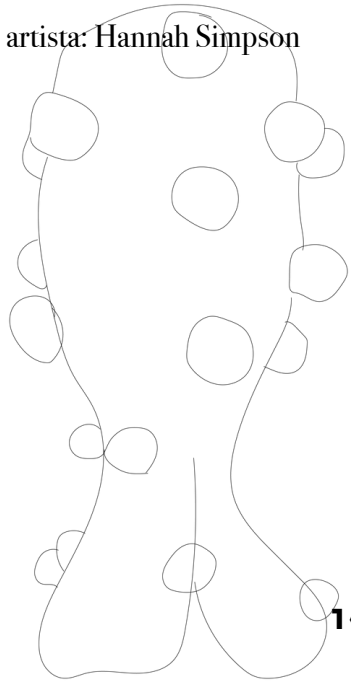

14€

tiny disco

como una fiesta en un vaso

(ingredientes):

mezcal, fresa, piña, pomelo, lima y
refresco de pomelo casero

artista: Martine Thoelen

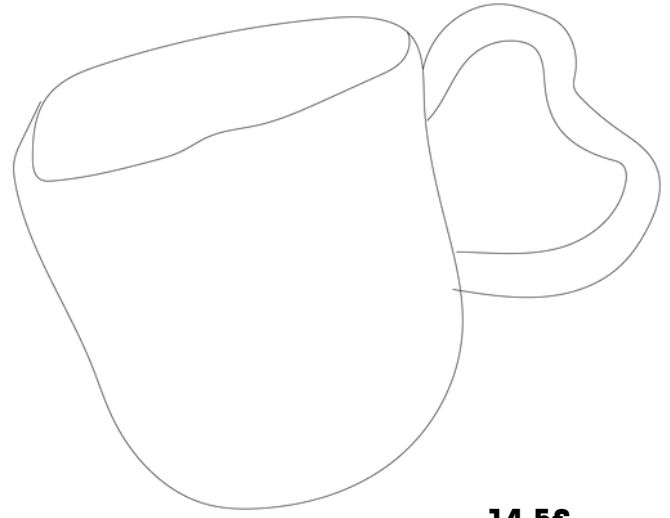

14,5€

ace of hearts

no vayas de farol, tenemos la mano ganadora

(ingredientes):

ginebra, vermut blanco, limón, frambuesa y rosas

artista: Justine Menard

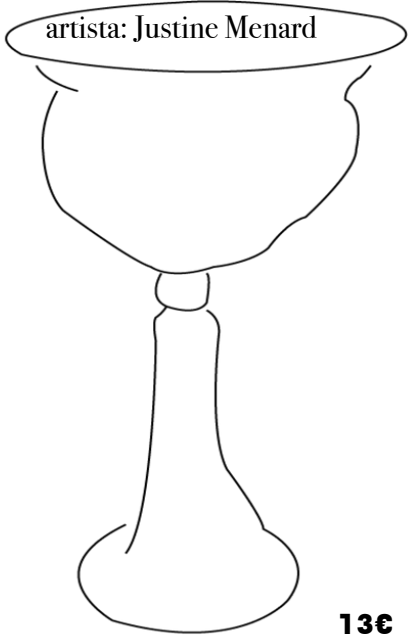

13€

muy-tasty

comienza con un agitado y termina con un ronroneo

(ingredientes):

mezcla de rones, licor de naranja, lima y piña especiada

artista: Alfonso Reyes

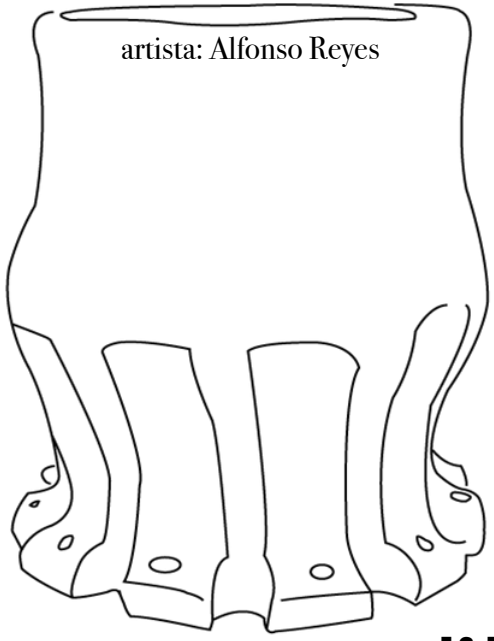

13,5€

say no more

deja que el sabor hable

(ingredientes):

whisky, licor de almendras, limón, naranja y cereza

artista: Anna Demidova

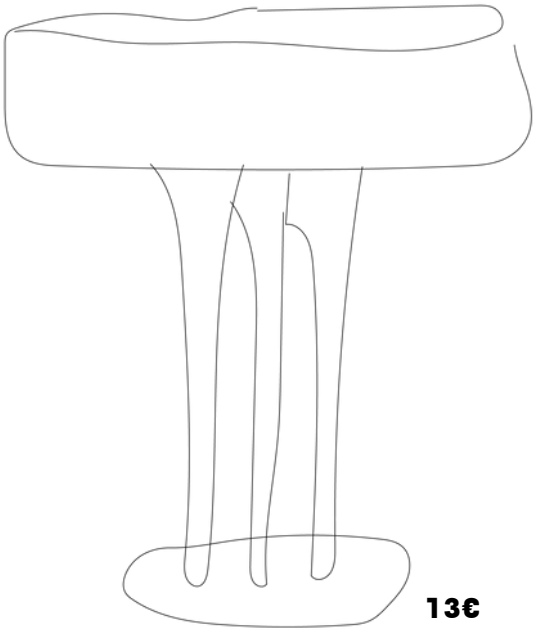

13€

x-rated martini

líneas borrosas y malas decisiones

(ingredientes):

vodka, licor de flor de saúco, limón, fruta de la pasión, frambuesa y rosas

artista: Anna Demidova



13€

slap da basil

botánicos portándose mal (y nos encanta)

(ingredientes):

ginebra, licor de hierbas, lima, albahaca con tónica Indian

artista: trobar

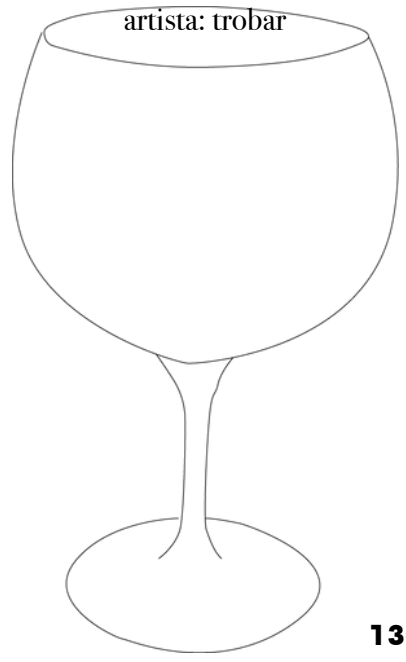

13€

mexican blood

un viaje por carretera de Oaxaca a Jalisco

(ingredientes):

tequila de achiote, licor de maíz, tomate picante, lima con corona y sal de gambas

artista: Teresa Monmas

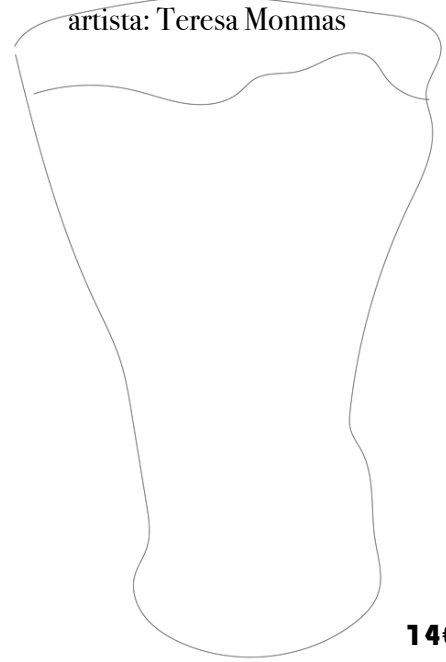

14€

okita e bossa

delicado como el origami, salvaje como el carnaval

(ingredientes):

cachaça, licor de melón, manzana, lima, jengibre y cardamomo con wasabi

artista: Anna Demidova

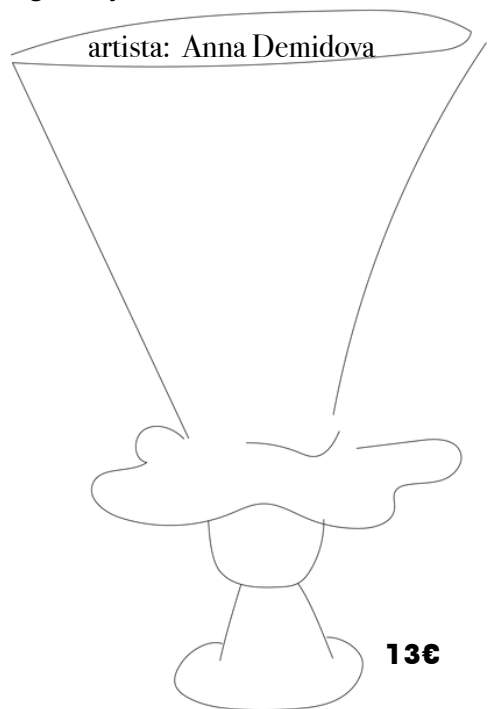

13€

sol & sip

españa dentro de un vaso

(ingredientes):

vino tinto o espumoso, mezcla secreta de licores, pomelo, melocotón, naranja y sandía

artista: trobar



13€

amore al amaro

amarga como tu ex,
pero mucho más divertida

(ingredientes):

ginebra, vermut rojo, amaro,
licor de naranja amarga y cava.

artista:
Trobat Casa



13€

pinky promise

un sorbo y tus labios
estarán sellados, casi...

(ingredientes):

tequila blanco, lima, soda de
pomelo casera y sal de naranja

artista:
trobar

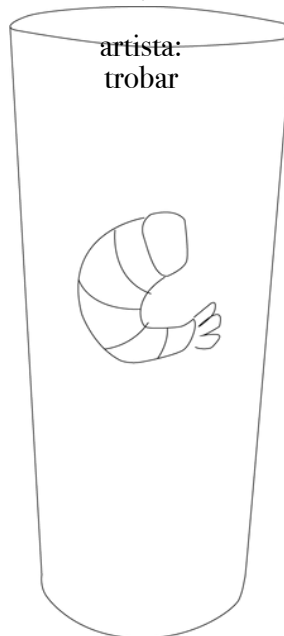

13€

tea is my calling

son las cinco de la tarde en algún lugar

(ingredientes):

ginebra, té negro helado,
melocotón, limón y menta

artista:
Anna Demidova

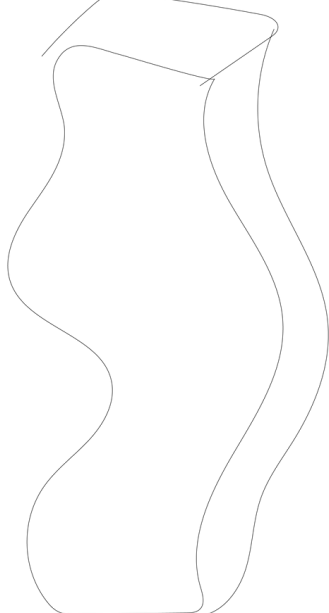

13,5€

pinch & a punch

el ron no está invitado
sólo se permiten **VIPs** ahumados

(ingredientes):

whisky, mezcal, lima y piña
especiada

artista: Laura Rubio Bañón

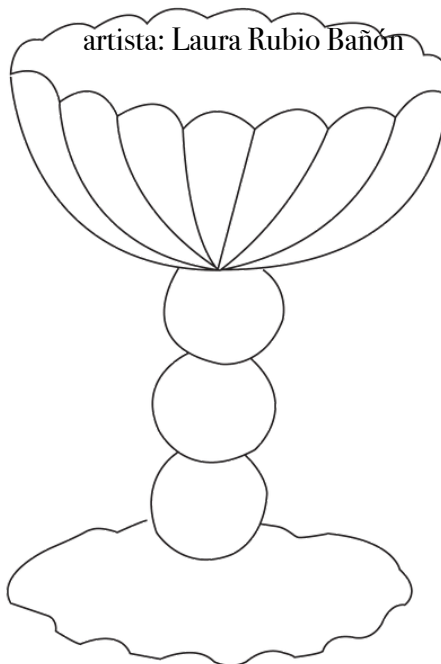

14€

(spritz time!)

soller spritz

licor de naranja, vino espumoso , pomelo y soda

13€

donghi's spritz

limoncello casero, vino espumoso, lima y soda

13€

venice spritz

Licor amargo italiano, vino espumoso, naranja y soda

12€

boss spritz

licor de flor de saúco, vino espumoso, menta, limón y soda

14€

combinados, a nuestra manera

nuestros combinados se elaboran con licores de primera calidad,
refrescos caseros o artesanos locales - todos **€12**

the cuban

ron y cola de cereza

sunset with friends

tequila reposado y naranjada

lemon-aid

vodka y limonada

brazillian soul

cachaça y soda de pomelo con rosas

french kiss

brandy y zumo de manzana

harakiri

mezcal y tónica de chile

mare nostrum

ginebra y tónica mediterránea

the outlaw

scotch whisky y soda de jengibre

digestives

Donghi's limoncello

6€

cuando la vida te da limones... haz limoncello, no limonada. nuestro limoncello
es una antigua receta familiar de nuestro copropietario italiano.
confíe en nosotros, uno nunca es suficiente.

booze free zone

¿no bebes esta noche? nosotros te ayudamos. explore nuestra selección de deliciosos cócteles, todos sin alcohol.

easy peasy

que corra el aire

(ingredientes):

mezcal sin alcohol, fresa, piña, pomelo y lima

artista: Martine Thoelen

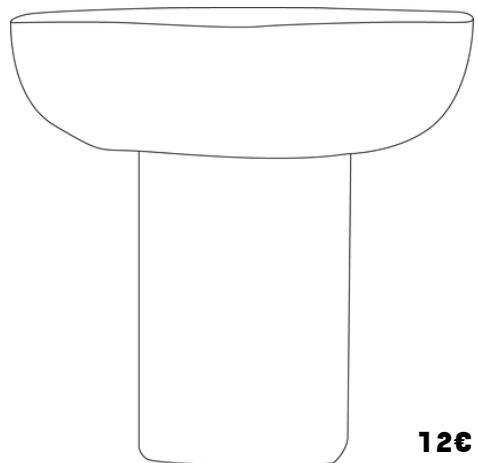

12€

pachamama

menos residuos, más sabor

(ingredientes):

tequila sin alcohol, naranja, mango chutney, lima y vainilla

artista: Hannah Simpson

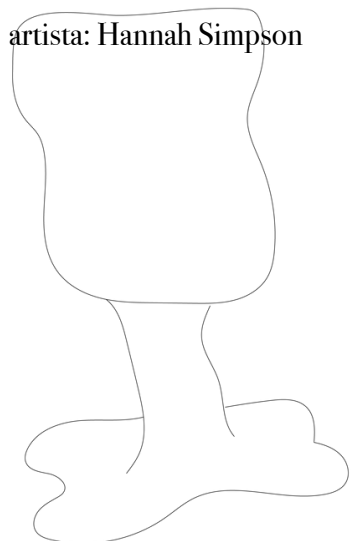

12€

t

apple of my eye

como un flechazo pero sin complicaciones

(ingredientes):

vodka sin alcohol, manzana, limón, menta, jengibre y cardamomo

artista: trobat casa

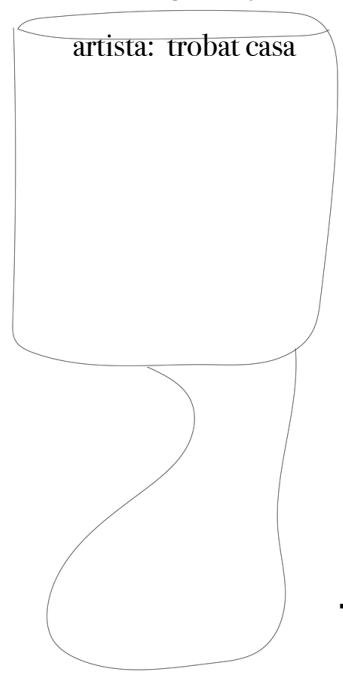

12€

bitter blossom

toda la ralladura, sin líos

(ingredientes):

vino espumoso sin alcohol y licor amargo italiano con pomelo

artista: trobar

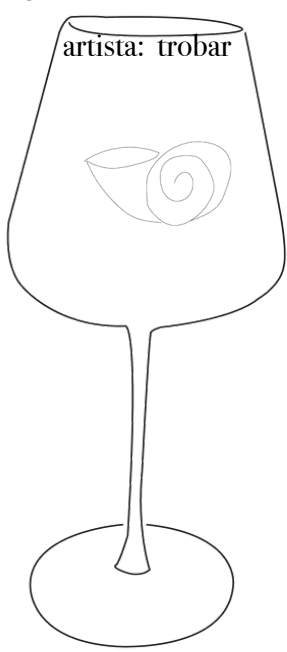

12€

r

nutty by nature

cuerpo de almendra, cero resaca

(ingredientes):

amaretto y whisky sin alcohol, limón, naranja y piña especiada

artista: trobat Casa

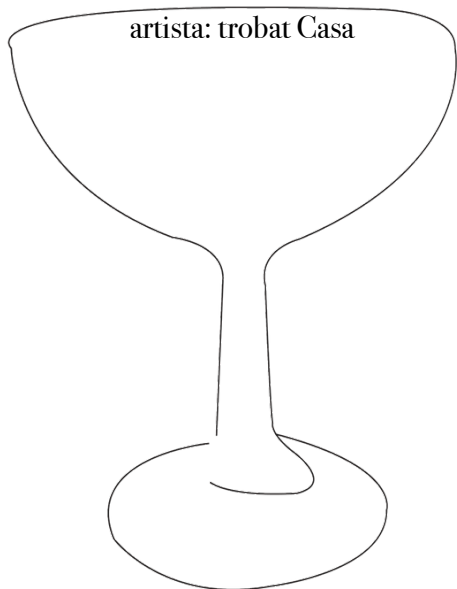

12€

midnight velvet

fiesta hasta tarde... despierta genial

(ingredientes):

licor de café y ron oscuro sin alcohol, espresso frío y coco tostado

artista: Laura Rubio Banon

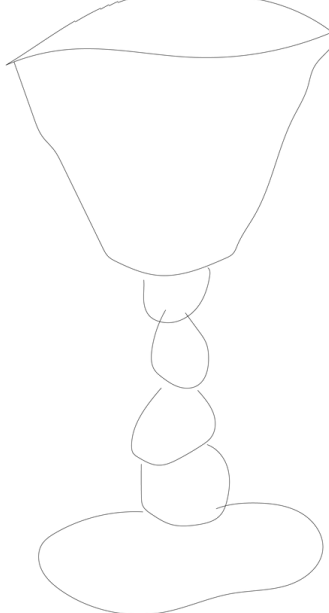

12€

citrus affair

el único triángulo amoroso que necesitas

(ingredientes):

ron blanco sin alcohol, fruta de la pasión, lima, kiwi, hierba limón y manzanilla

artista: Teresa Monmas

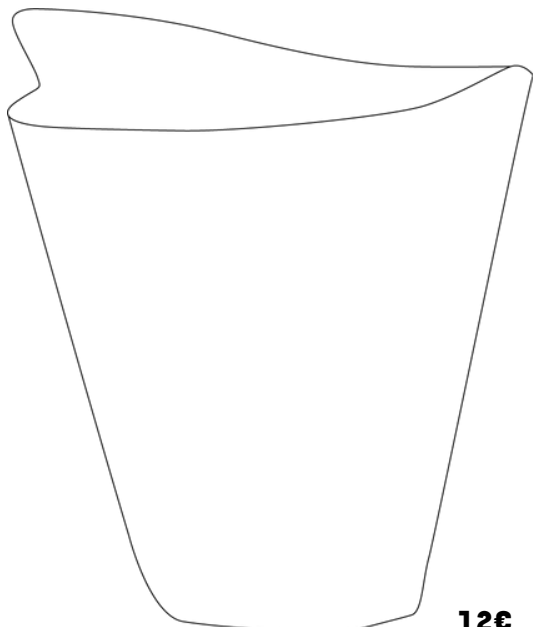

12€

see who's to blame

sonríe, coquetea, señala con el dedo... ¿quieres jugar?

(ingredientes):

ginebra sin alcohol, pepino, naranja, melocotón, moras y flor de hibisco

artista: trobar

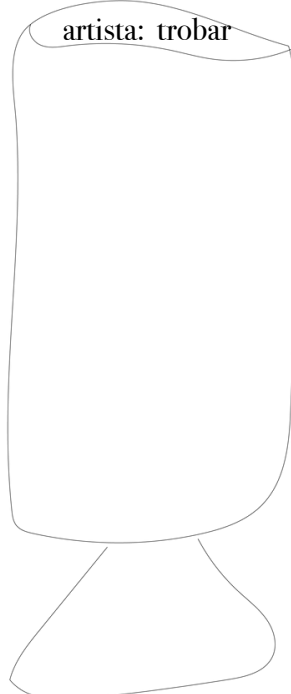

12€

refrescos

black iced tea	
trobar ginger ale soda	
trobar grapefruit soda	
puig cola (Mallorca)	
puig cola zero (Mallorca)	
puig lemon soda (Mallorca)	
puig orange soda (Mallorca)	3.5€

zumos frescos

manzana	
piña	
naranja	
melocotón	
	4.5€

agua

sin gas

(500ml): **2,5€**

(1L): **3,5€**

con gas

(500ml): **3€**

(1L): **4€**

cerveza

¿no le gustan los cócteles? no nos identificamos con usted, pero lo respetamos. En su lugar, explore nuestra selección de vinos y cervezas en.

peroni	5€
coronita	4,5€
beer lovers Mallorca broil (a classic craft beer)	6,5€
beer lovers Mallorca dipa (double india pale ale)	6,5€

kombucha portuguesa con alcohol

copa:

ummi kombucha - mango tumeric	6€
ummi kombucha - hibiscus berry	6€

vino

espumoso

vinestar ancestral pet nat (Spain)

pertois-moriset les quatre terroirs (France)

ruinart brut (France)

copa:

8€

botella:

40€

100€

130€

blanco

remordiento bodega cerron chardonnay (Spain)

lirondo pet nat (Spain)

copa:

7€

7.5€

botella:

35€

38€

t

rosado

mas de canet blanc (Mallorca)

s vins clarete (Mallorca) (rose white wine blend)

hada furthmann rasado roshada (Mallorca)

copa:

7,5€

botella:

38€

50€

55€

r

tinto

caminando tempranillo (Spain)

gre2 garnacha (Spain)

matas altas (Spain)

copa:

7€

8€

botella:

35€

40€

50€

vino

orange

s vins p orange (Spain)

botella:

50€

sin alcohol

botella:

kolonne null riesling white wine

28€

kolonne null rosé rose

28€

oddbird GSM vino red wine

32€

freixenet 0,0% alcohol free sparkling wine

20€

vermut

t

copa:

cueva negro vermut

5€

martini riserva rubino

6€

martini riserva ambrato

6€

antica formula

8€

r

trobat.co se creó como un mercado en línea para mostrar y vender la obra de más de 35 artistas emergentes de todo el mundo, una colección seleccionada de obras de arte originales que celebra el talento, la artesanía y la expresión creativa. nuestra tienda en línea se creó en 2021 y realiza envíos a todo el mundo. a partir de ahí nació **trobar**, nuestro espacio físico y conceptual para experimentar estas obras en persona y adentrarse en el mundo que hemos creado. el espacio en sí fue diseñado en colaboración con nuestro fundador y artistas **trobat.co** junto con toda nuestra vajilla. en catalán, **trobat** significa «encontrado», que representa los tesoros que hemos descubierto y reunido en línea, mientras que **trobar** significa «encontrar», el acto de buscar, de conectar, de descubrir la belleza. Es el lugar al que ha venido para encontrar y experimentar lo que nosotros ya hemos encontrado para usted.

al comprar con nosotros, está
apoyando directamente el arte
hecho a mano por artesanos
creativos y prometedores de
todo el mundo.

todo lo que ves está a la venta en www.trobat.co/trobar
síguenos @trobat.co @trobar_

*scan to
shop*



@trobat.co

@trobar_

menüs:

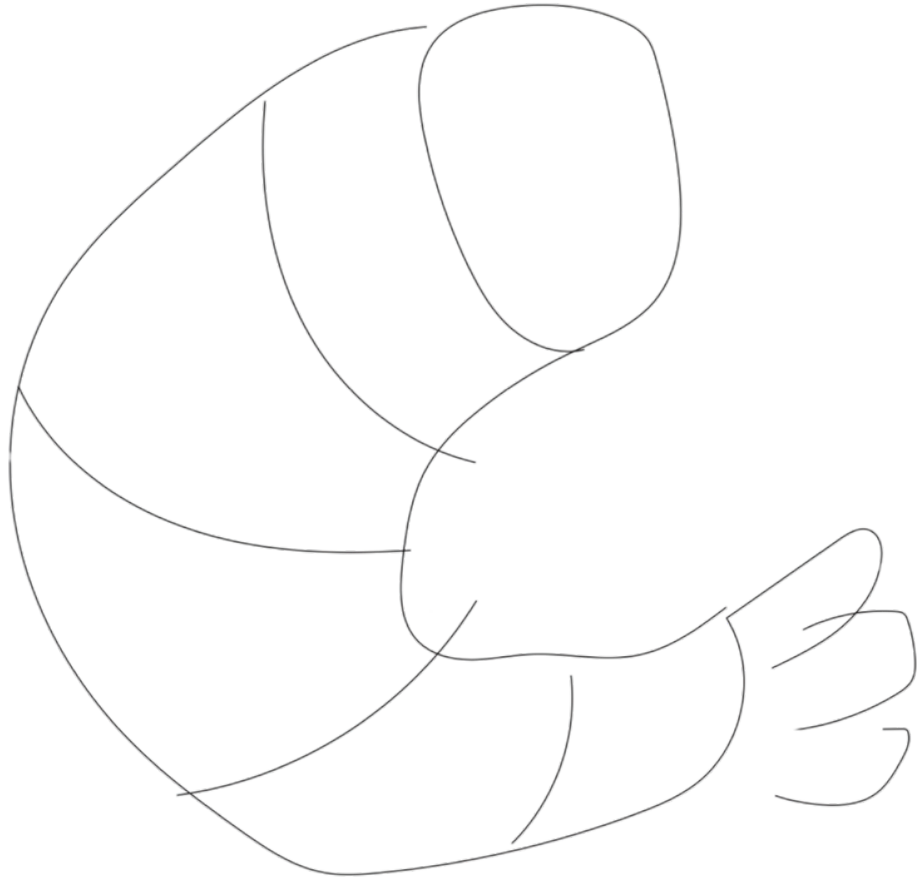

t

welcome to trobar
the place where:

The eternal seekers go crazy when the perfect song comes up in the perfect place, at the perfect time. They become soulmates by just saying 'I love the way you think'. They collect art because of the impact on their lives, not their pockets. They save all the umami experiences in the most intricate corners of the mind. And collect all that makes life worth living day after day, time and time again. That's why they always come back here; to find everything they once found. Just like you do.

r

back
to
find,
trobar

trobar kitchen

antipasti

focaccia al rosmarino / focaccia mit rosmarin €3.5 p.p V VGN
ARTIST: CONSTANZA CECCHETTO

olive marinate mediterranee / mediterran marinierte oliven €5 V VGN GF
ARTIST: CONSTANZA CECCHETTO

parmigiano / parmesankäse in stücken €8 V GF
ARTIST: ANNA DEMIDOVA

peperoni marinati / marinierte paprika €6 V VGN GF
ARTIST: ANNA DEMIDOVA

caponata / caponata €8 V VGN GF
ARTIST: BIEL MIRALLES

sarde in marinata al trobar / sardinen in trobar marinade €10 GF
ARTIST: ALFONSO REYES

schiacciata di zucchine alla maiorchina / zucchini mit sizilianischen €8 V VGN GF
ARTIST: ALFONSO REYES

caprese 2.0, reimmaginata / caprese 2.0, neu interpretiert €9 V GF
ARTIST: MARTINE THOELLEN

insalata di stagione / salat der saison €8 V VGN GF
ARTIST: HANNAH SIMPSON

burrata, a modo nostro / burrata, auf unsere art €12 V GF
ARTIST: LAURA RUBIO BANON

arancini al ragù / arancini mit ragout €4.5 u.d
ARTIST: CONSTANZA CARRASCO

involtini di manzo / rindfleisch-rollen €10
ARTIST: ALFONSO REYES

vitello tonnato / kalbfleisch mit thunfischsauce €14 GF
ARTIST: CONSTANZA CARRASCO

polpette / frikadellen €14 GF
ARTIST: CONSTANZA CECCHETTO

calamari ripieni / gefüllte calamari €16
ARTIST: ALFONSO REYES

parmigiana di melanzane / aubergine parmigiana €10 V GF
ARTIST: TROBAT CASA

lasagne ragu / lasagne mit bolognese €14
ARTIST: TERESA MONMAS

buon appetito!

V = vegetarianerin VGN = vegan GF = glutenfrei

sollten sie allergien haben, informieren sie uns bitte.



dolci

palline di tiramisù / tiramisù-bällchen €2 bällchen
ARTIST: MISTER PIRO

biscotti di mandorle / mandelplätzchen mit kirsche €2 pro stück
ARTIST: MISTER PIRO

cannoli / cannoli €2.5 pro stück
ARTIST: MISTER PIRO

brioche con gelato di limone / brioche mit zitronengelato €6
ARTIST: CONSTANZA CECCHETTO

semifreddo con noci croccanti tostate / semifreddo mit gerösteten knackigen nüssen €6.5 V GF
ARTIST: CONSTANZA CECCHETTO

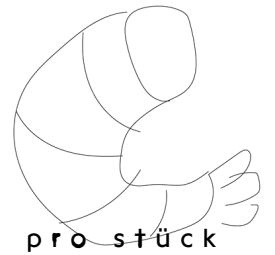

trobat.co wurde als online-marktplatz gegründet, um die werke von über 35 aufstrebenden künstlern aus aller welt zu präsentieren und zu verkaufen – eine kuratierte sammlung originaler kunstwerke, die talent, handwerk und kreativen ausdruck würdigt. unser online-shop wurde 2021 eröffnet und versendet weltweit. aus dieser grundlage entstand **trobar** – unser physischer, konzeptioneller raum, in dem Sie diese werke persönlich erleben und in die von uns geschaffene welt eintauchen können. die inneneinrichtung des raums selbst sowie unseres gesamten geschirrs wurde in zusammenarbeit mit unserem gründer und den künstlern von **trobat.co** gestaltet. auf katalanisch bedeutet **trobat** „gefunden“ und steht für die schätze, die wir online entdeckt und zusammengetragen haben; **trobar** hingegen bedeutet „finden“ – das suchen, verbinden und entdecken von schönheit. hier sind sie, um zu entdecken und zu erleben, was wir bereits für sie gefunden haben. mit Ihrem einkauf bei uns unterstützen sie direkt handgefertigte kunst von kreativen, aufstrebenden kunsthandwerkern aus aller Welt.

tischdekoration

teller von Constanza Company
besteck von Sebastião Lobo
servietten von trobat
weingläser von trobar
kandelaber von Rubble Workshop
untersetzer von Biel Miralles
wassergläser von trobar
salzschalen von trobat casa
kaffeetassen von Teresa Monmas

jedes unserer geschirre hat seine eigene, einzigartige geschichte. sie wurden entweder von **trobat-künstlern** in zusammenarbeit mit **trobar** entworfen, sind vintage-stücke aus unserer **retrobat**-Linie, eklektische stücke, die unser kurator aus unserer **objet-trobat**-reihe zusammengestellt hat, oder sie wurden von uns selbst gefertigt und sind teil unserer **trobat-casa**-kollektion. scannen Sie, um alles, was Sie sehen, und mehr zu kaufen.



@trobat.co



@trobar_



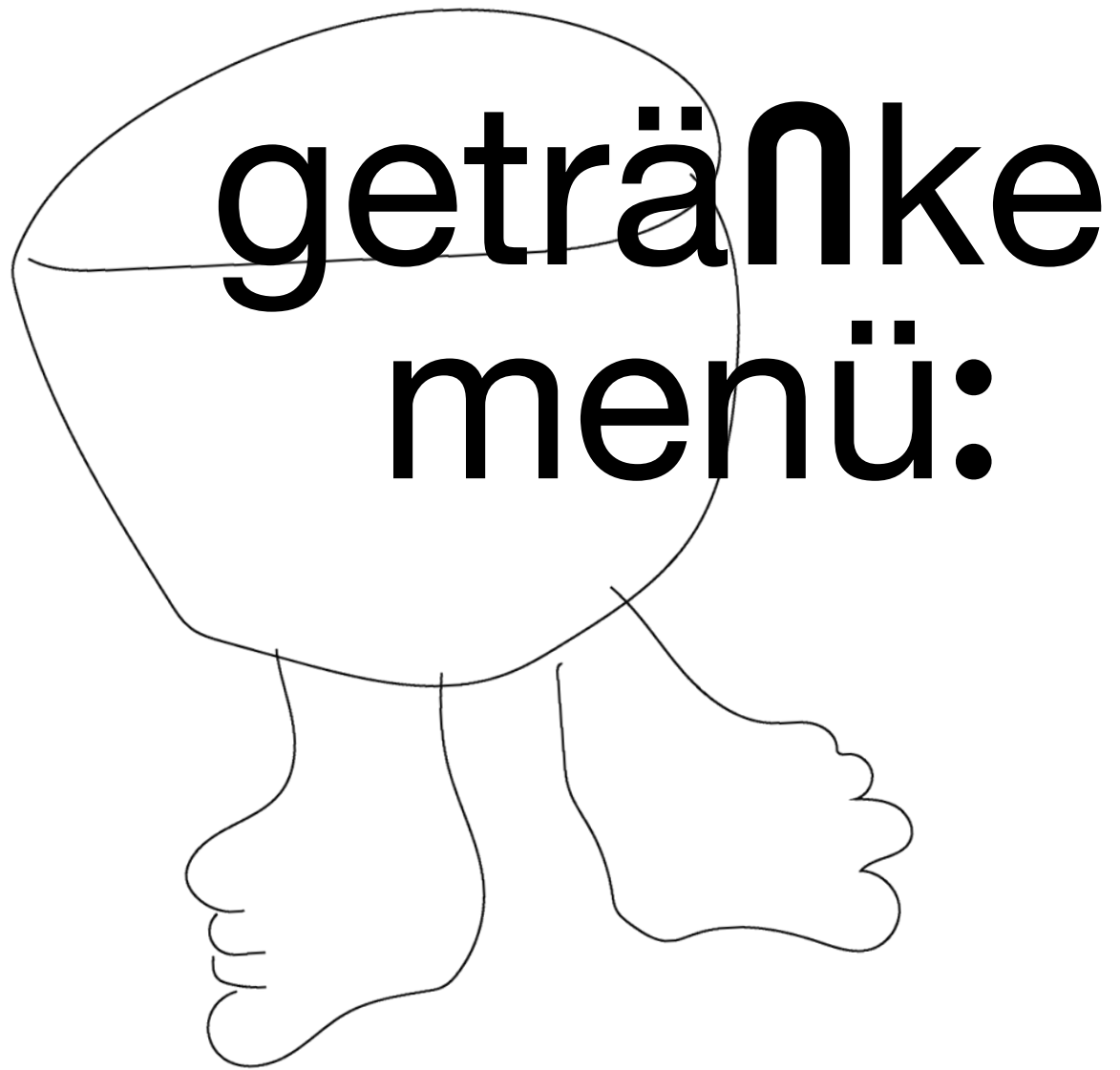

t

r

txin txin!

signatur-cocktails von trobar — kreiert von Luis Aguayo

unsere exklusive cocktail-kollektion wird mit hausgemachten zutaten und erstklassigen spirituosen zubereitet und in unverwechselbaren, handwerklich hergestellten gläsern serviert, die unser engagement für kreativität, qualität und abfallfreiheit widerspiegeln.

alle unsere „glaswaren“ werden entweder von trobat-künstlern in zusammenarbeit mit trobar geschaffen, sind vintage-stücke aus unserer retrobatik-linie, sind eklektische stücke, die unser kurator aus unserem objecte trobat-sortiment gesammelt hat, oder sie werden von uns hergestellt und sind teil unserer trobat casa-kollektion.

alle sind erhältlich unter www.trobat.co/trobar

folgen sie uns @trobat.co @trobar_

the artist

it's not just a drink, it's a lifestyle choice

(zutaten):

wodka, orangenlikör, limette, brombeere und hibiskus

artist: Laura Rubio Bañón

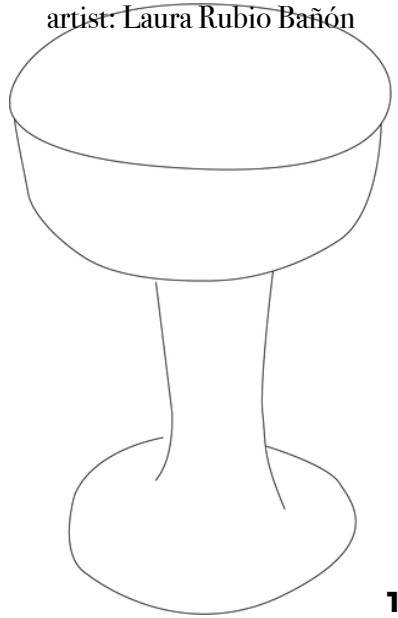

13€

get caught in the rain

sometimes getting wet is part of the plan

(zutaten):

kokosnuss rum, ananas, limette, geröstete kokosnuss & zimt

artist: trobar

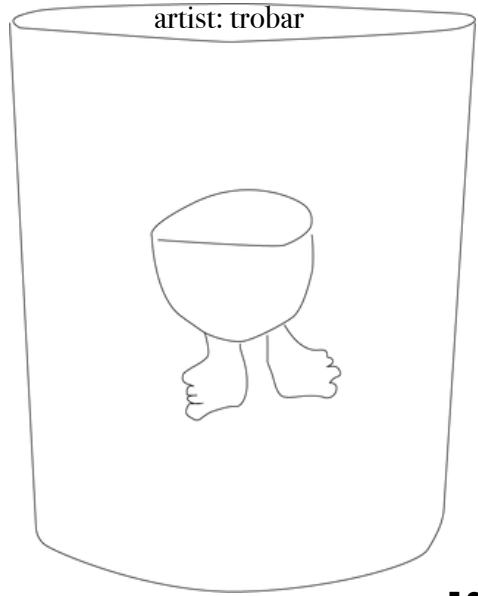

13,5€

green smoke

you're now in the alarm-free zone

(zutaten):

gin, mezcal, gurke, zitrone, minze, ingwer & kardamom

artist: Hannah Simpson

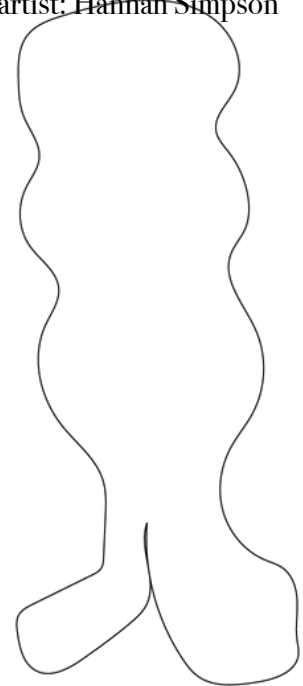

14€

spicy dahlia

where flowers flirt and chilli's sting

(zutaten):

reposado tequila, orange & chipotle likör, limette, agave

artist: trobat casa

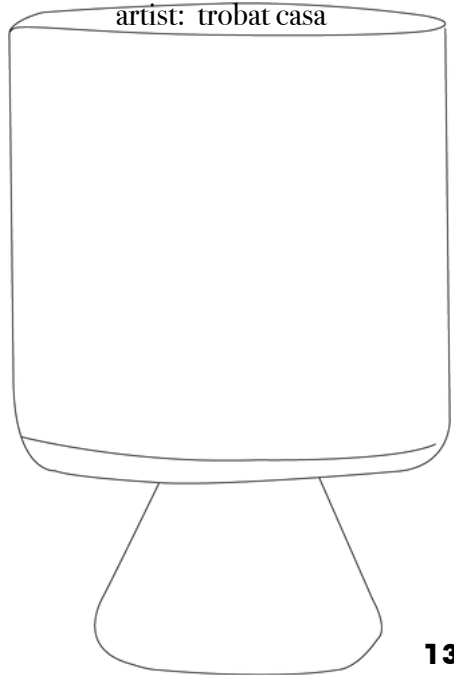

13,5€

born in milan

mary went to Italy, she never
texted back

(zutaten):

parmesan-wodka, hausgemachter
limoncello, pikante tomate, grapefruit
und basilikum.

artist: Teresa Monmas

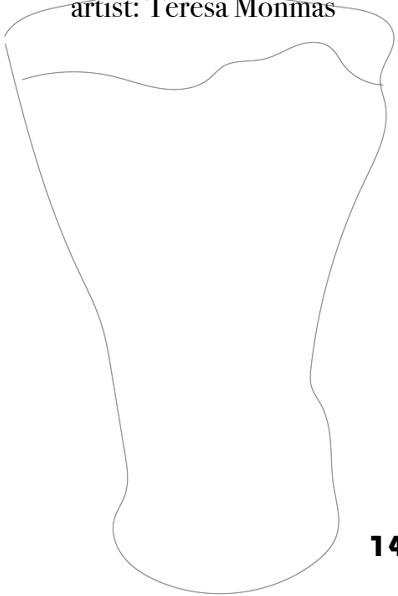

14€

but first, coffee

let's handle one crisis at a time

(zutaten):

wodka, kaffeelikör, kalt gebrühter
espresso & vanille

artist: Laura Rubio Banon

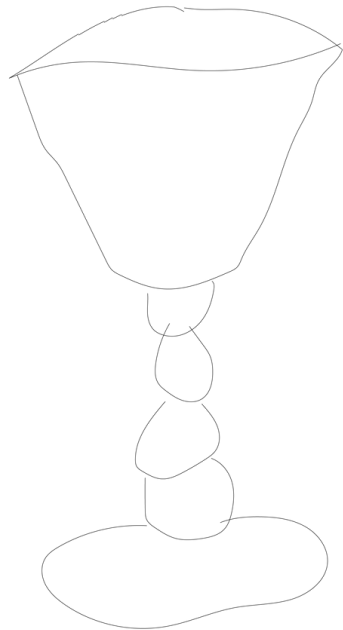

13,5€

matcha la vista

after all that sea, we landed on sorbet

(zutaten):

wodka, apfelbrand, limette, minze,
hausgemachtes matcha- & yuzu-Sorbet

artist: Justine Menard

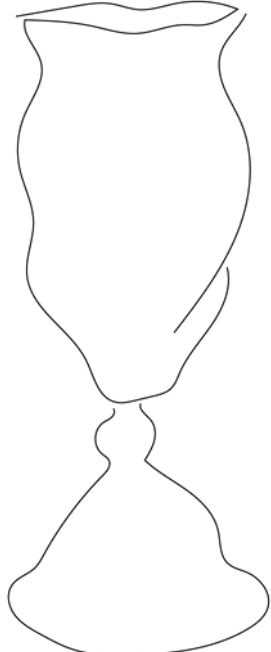

14€

purple & tonic

when a g&t just won't cut it

(zutaten):

schmetterlingsblüten-gin, holunderblüten-
likör, zitrone und lavendel, gekrönt mit
mediterranem tonic parmesan-wodka,
hausgemachtem limoncello, würziger
tomate, grapefruit, basilikum und rosmarin

artist: trobar



13€

la concha

your new guilty pleasure, washed ashore

(zutaten):

12 jahre scotch whiskey, kiwi, zitrone, kamille und zitronengras

artist: Constazna Cecchetto & aus objecte trobat

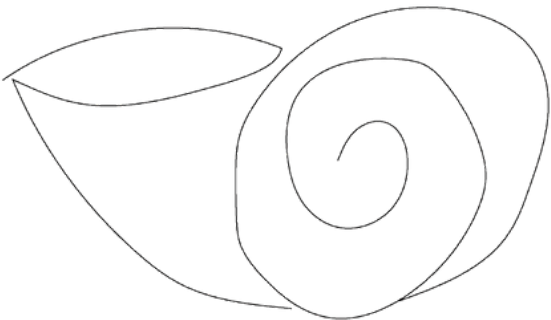

15€

mangoco

you'll be loco for it

(zutaten):

dunkler rum, mango-chutney, orange, limette und geröstete Kokosnuss

artist: Hannah Simpson

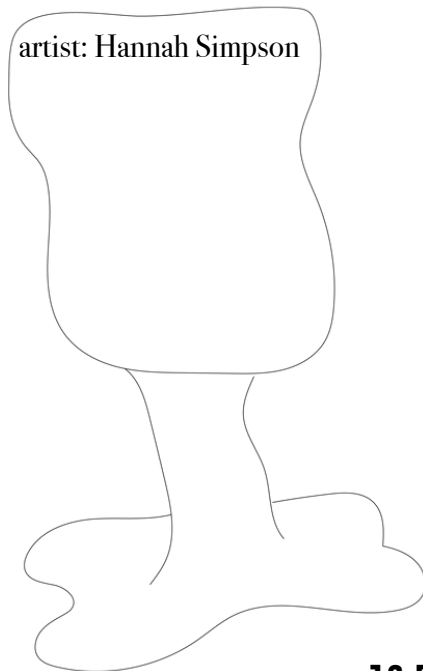

13,5€

sakxy nikkei

peru meets Japan, passion sparks and flavours dance

(zutaten):

sake, pisco, passionsfrucht, limette und vanille

artist: Hannah Simpson

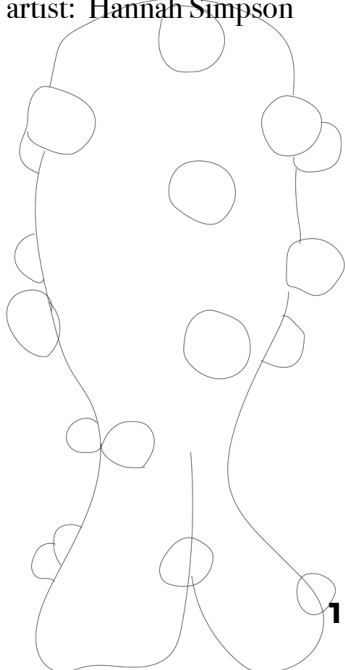

14€

tiny disco

like a party in a glass

(zutaten):

mezcal, erdbeere, ananas, grapefruit, limette und hausgemachte pomelo-soda

artist: Martine Thoelen

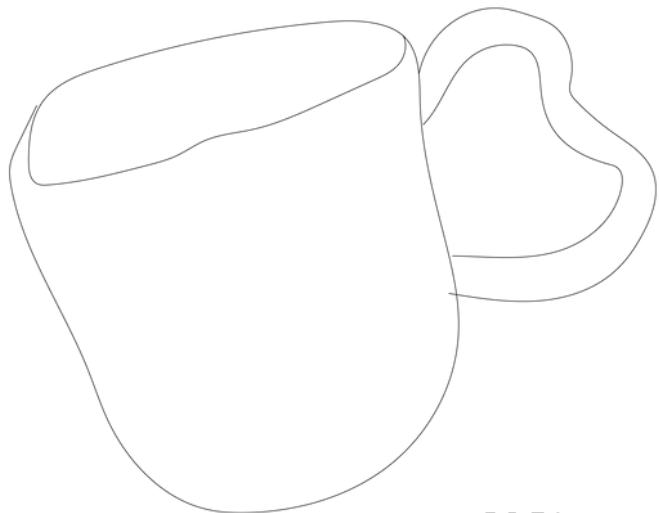

14,5€

ace of hearts

don't bluff, we have the winning hand

(zutaten):

gin, weißer wermut, zitrone, himbeere und rose

artist: Justine Menard

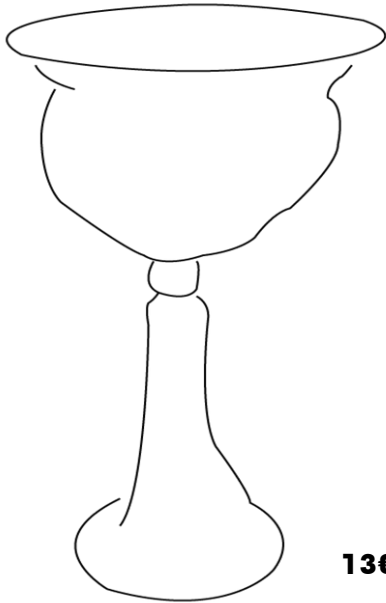

13€

muy-tasty

starts with a shake, ends with a purr

(zutaten):

rummischung, orangenlikör, limette und falernum

artist: Alfonso Reyes

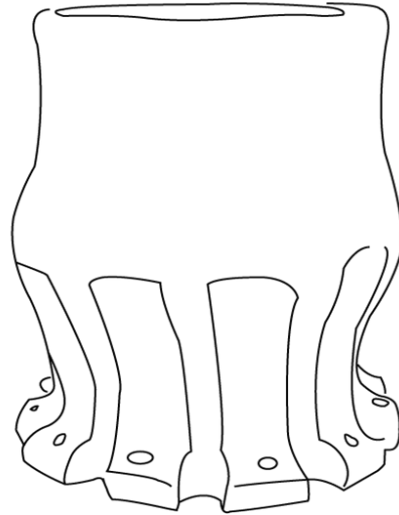

13,5€

say no more

let the flavour do the talking

(zutaten):

bourbon whiskey, amaretto-likör, zitrone, orange und kirsche

artist: Anna Demidova

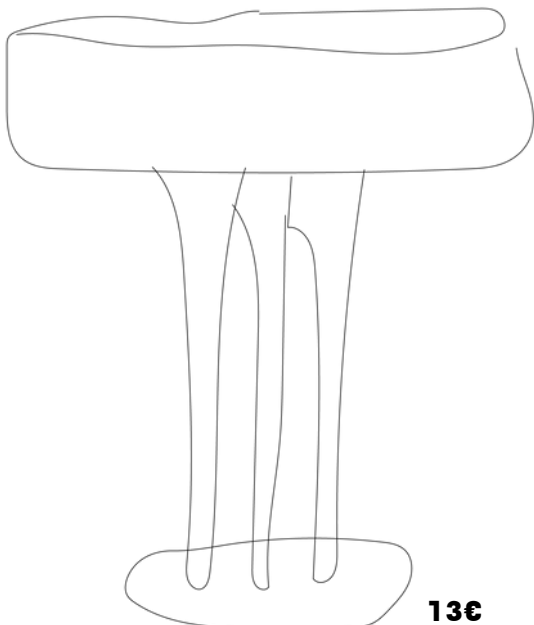

13€

x-rated martini

blurred lines and bad decisions

(zutaten):

wodka, holunderblütenlikör, passions frucht, zitrone, himbeere & rose

artist: Anna Demidova

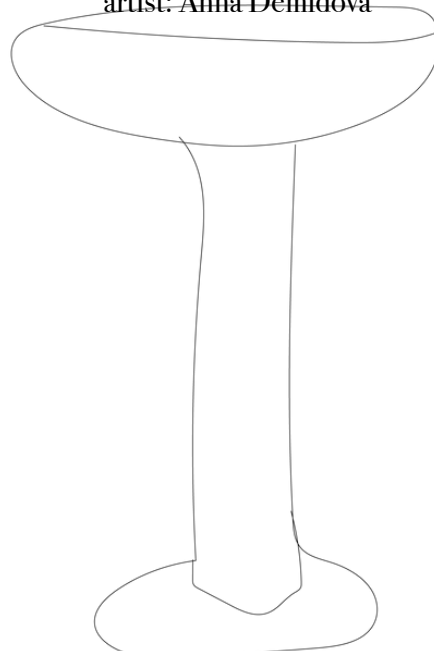

14€

slap da basil

botanicals behaving badly (and we love it)

(zutaten):

gin, limone, basilikum, & kräuterlikör, gekrönt mit indischem tonic

artist: trobar

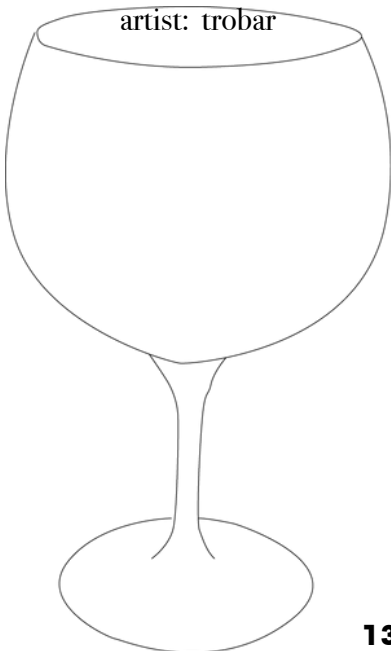

13€

mexican blood

a road trip from oaxaca to jalisco

(zutaten):

achiote-tequila, maislikör, würzige tomate und limette, gekrönt mit corona

artist: Teresa Monmas

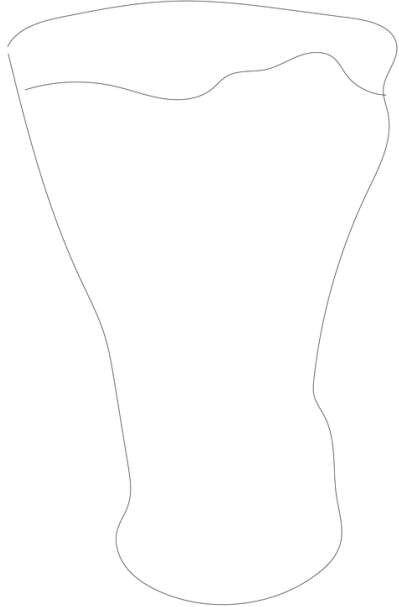

14€

okita e bossa

delicate like origami, wild like carnival

(zutaten):

cachaça, melonenlikör, apfel, limette, ingwer & kardamom mit einem hauch von wasabi

artist: Anna Demidova

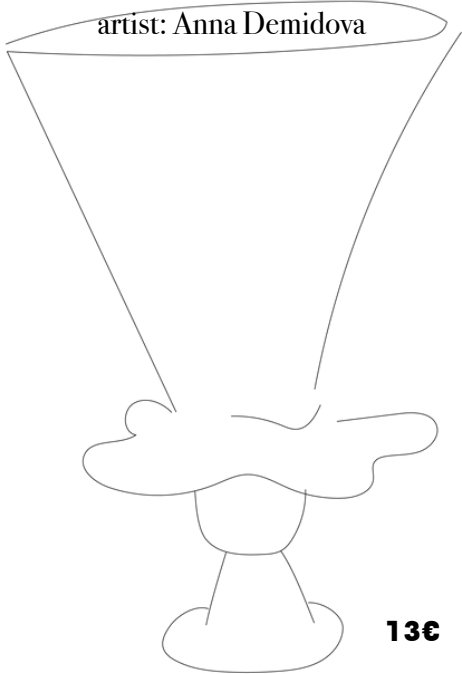

13€

sol & sip

spain in a glass

(zutaten):

rotwein oder processo, geheimer liquermischung, grapefruit, orange, pfirsich & wassermelone

artist: trobar

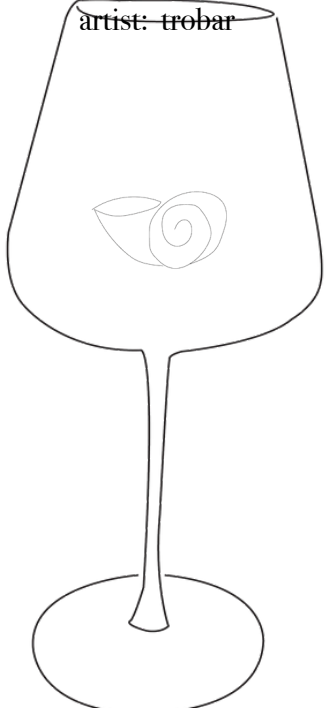

13€

amore al amaro

bitter like your ex, but way more fun

(zutaten):

gin gemischt mit süßem wermut, italienischem bitterlikör, bitterorangenlikör und cava

artist: trobat Casa

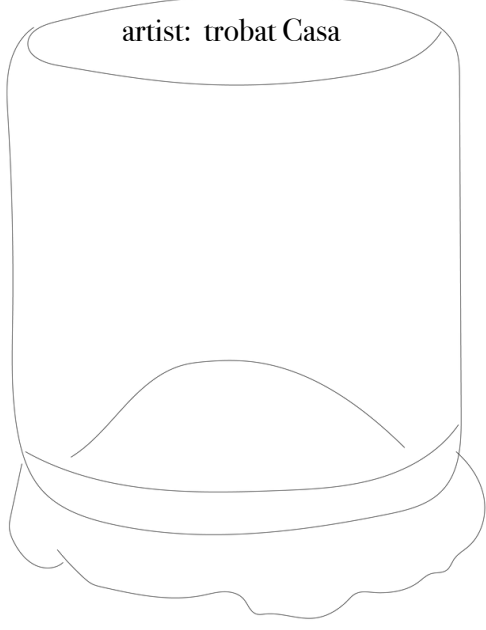

13€

pinky promise

one sip and your lips are sealed, mostly...

(zutaten):

silver tequila, limette und hausgemachte grapefruitlimonade

artist: trobar

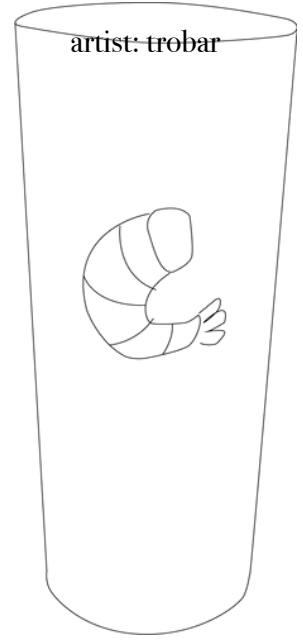

13€

tea is my calling

it's five o'clock somewhere

(zutaten):

gin, eistee, pfirsich, zitrone und minze

artist: Anna Demidova

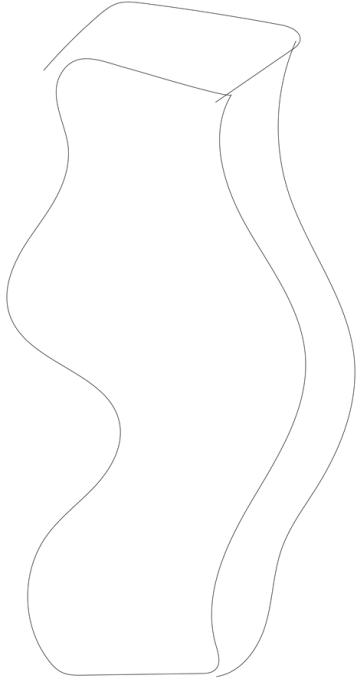

13,5€

pinch & a punch

rum's not invited only smoky VIPs allowed

(zutaten):

whisky, mezcal, limette und falernum

artist: Laura Rubio Bañón

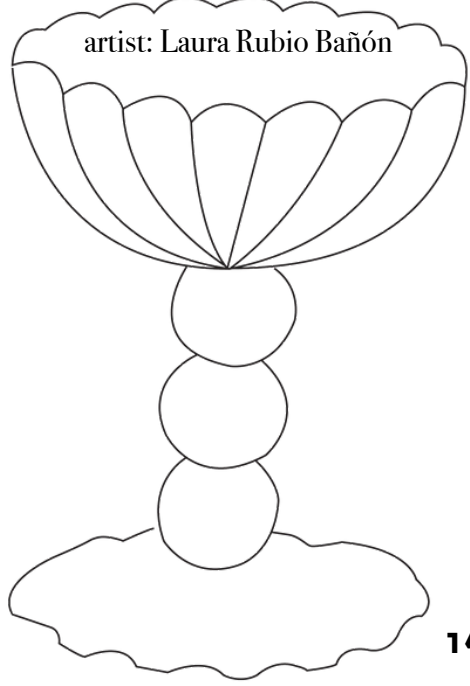

14€

spritz time!

- soller spritz** **13€**
orangenlikör, sekt und hausgemachte grapefruitlimonade
- donghi's spritz** **13€**
hausgemachter limoncello, sekt, limette und soda
- venice spritz** **12€**
italienischer bitterlikör, sekt, orange und soda
- boss spritz** **14€**
holunderblütenlikör, sekt, basilikum, zitrone & soda

longdrinks, unsere art

hergestellt mit premium spirituososen, hausgemachten oder lokalen handwerkslimonaden - alle **12 €**

the cuban
rum & cola

sunset with friends
reposado tequila & passionsorange

lemon-aid
wodka & limonade

brazillian soul
cachaça & Grapefruit

french kiss
brandy & apfelsaft

harakiri
mezcal & chili-tonic

mare nostrum
gin & mediterraner tonic

the outlaw
scotch whiskey und ingwerbier

digestives

Donghi's limoncello

6€

wenn das leben dir zitronen gibt... mach limoncello, keine limonade. unser limoncello ist ein langjähriges familienrezept unseres italienischen miteigentümers. glauben sie uns, einer ist nie genug.

booze free zone

heute abend nichts trinken? wir sind für sie da. entdecken sie unsere auswahl an köstlichen mocktails, alle ohne alkohol.

easy peasy

keep it breezy

(zutaten):

alkoholfreier mezcal, erdbeere, ananas, grapefruit & limette

artist: Martine Thoelen

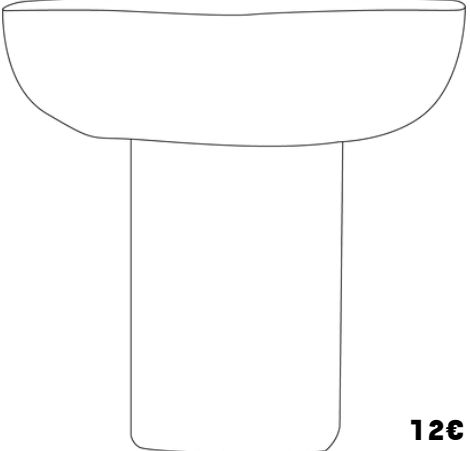

12€

pachamama

less waste, more taste

(zutaten):

alkoholfreier tequila, mango chutney, orange, limette & vanille

artist: Hannah Simpson

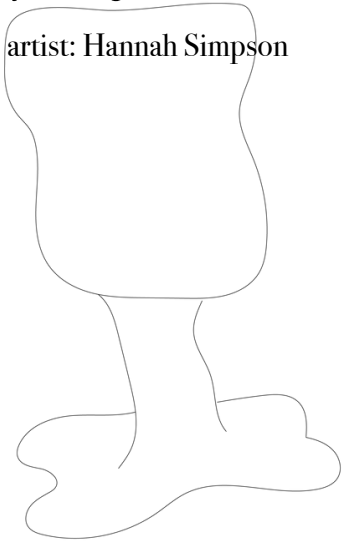

12€

t

apple of my eye

like your crush without the fuss

(zutaten):

alkoholfreier qodka, apfel, zitrone, minze, ingwer & kardamom

artist: trobat casa

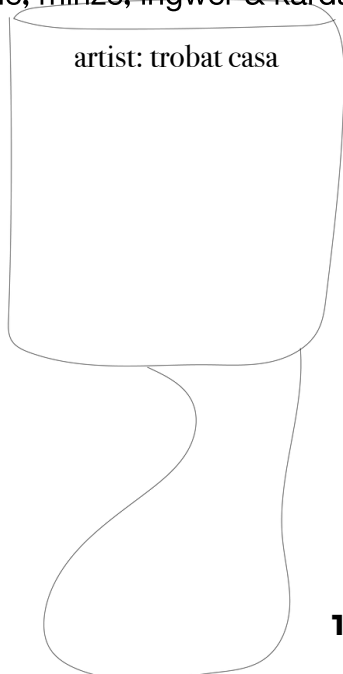

12€

bitter blossom

all the zest, none of the mess

(zutaten):

sekt & italienischer bitterlikör mit einem spritzer orange

artist: trobar



12€

r

nutty by nature

almond charm, zero harm

(zutaten):

alkoholfreier amaretto, alkoholfreier whisky, orange, zitrone & gewürzte ananas

artist: trobat casa

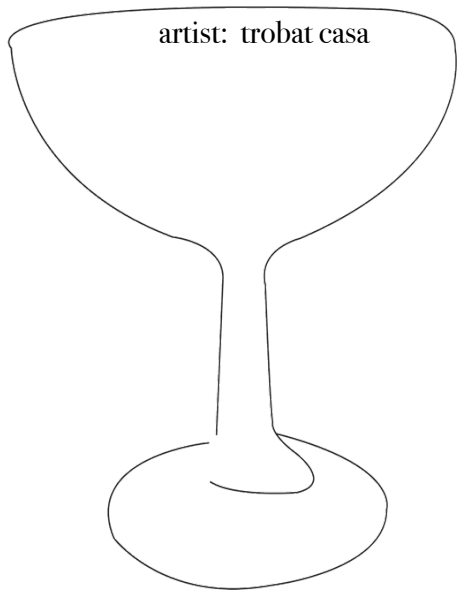

12€

midnight velvet

party late, wake up great

(zutaten):

alkoholfreier kaffeelikör, alkoholfreier dunkler rum, kalt gebrühter espresso & geröstete kokosnuss

artist: Laura Rubio Banon

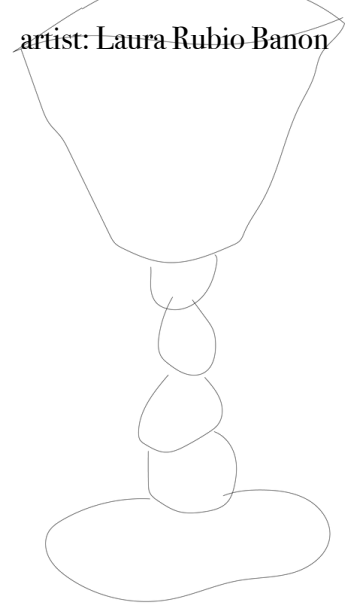

12€

citrus affair

the only love triangle you need

(zutaten):

alkoholfreier weißer rum, passionsfrucht, limette, kiwi, zitronengras und kamille

artist: Teresa Monmas

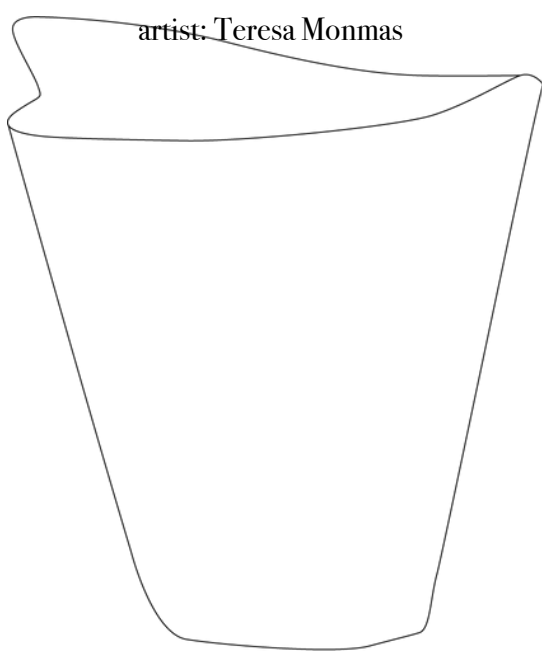

12€

see who's to blame

smile, flirt, point fingers... wanna play?

(zutaten):

alkoholfreier gin, gurke, orange, brombeere & hibiskus

artist: trobat casa

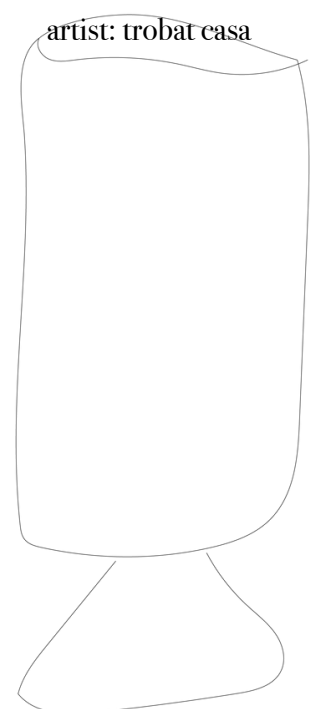

12€

Limonaden & Tee

black iced tea	
trobar ginger ale soda	
trobar grapefruit soda	
puig cola (Mallorca)	
puig cola zero (Mallorca)	
puig lemon soda (Mallorca)	
puig orange soda (Mallorca)	3.5€

frischer saft

apfel	
ananas	
orange	
pfirsich	
	4.5€

wasser

still			spritzig		
(500ml):	2,5€	(1L):	3,5€	(500ml): 3€	(1L): 4€

bier

sie mögen keine cocktails? wir können das nicht nachvollziehen, aber wir respektieren es.
entdecken Sie stattdessen unsere kuratierte auswahl an weinen und bier.

peroni	5€
coronita	4,5€
beer lovers Mallorca brot (a classic craft beer)	6,5€
beer lovers Mallorca dipa (double india pale ale)	6,5€

portugiesischer harter Kombucha

glas:

ummi kombucha - mango tumeric	6€
ummi kombucha - hibiscus berry	6€

wein

{ bubbles }

	glas:	die flasche:
vinestar ancestral pet nat (Spain)	8€	40€
pertois-moriset les quatre terroirs (France)		100€
ruinart brut (France)		130€

weißwein

	glas:	die flasche:
remordiento bodega cerron chardonnay (Spain)	7€	35€
lirondo pet nat (Spain)	7.5€	38€

t

{ rosenwein }

	glas:	die flasche:
mas de canet blanc (Mallorca)	7,5€	38€
s vins clarete (Mallorca) (rose white wine blend)		50€
hada furthmann rasado roshada (Mallorca)		55€

r

rotwein

	glas:	die flasche:
caminando tempranillo (Spain)	7€	35€
gre2 garnacha (Spain)	8€	40€
matas altas (Spain)		50€

wein

orangewein

s vins p orange (Spain)

die flasche:

50€

kein alkohol

die flasche:

kolonne null riesling white wine

28€

kolonne null rosé rose

28€

oddbird GSM vino red wine

32€

freixenet 0,0% alcohol free sparkling wine

20€

t

wermut

r

die flasche:

cueva negro vermut

5€

martini riserva rubino

6€

martini riserva ambrato

6€

antica formula

8€

trobat.co wurde als online-marktplatz gegründet, um die werke von über 35 aufstrebenden künstlern aus aller welt zu präsentieren und zu verkaufen eine kuratierte sammlung originaler kunstwerke, die talent, handwerk und kreativen ausdruck würdigt. unser online shop wurde 2021 eröffnet und versendet weltweit. aus dieser grundlage entstand **trobar** unser physischer, konzeptioneller raum, in dem sie diese werke persönlich erleben und in die von uns geschaffene welt eintauchen können. die inneneinrichtung des raums selbst sowie unseres gesamten geschirrs wurde in zusammenarbeit mit unserem gründer und den künstlern von **trobat.co** gestaltet. auf katalanisch bedeutet **trobat** „gefunden“ und steht für die schätze, die wir online entdeckt und zusammengetragen haben; **trobar** hingegen bedeutet „finden“ – das suchen, verbinden und entdecken von schönheit. hier sind sie, um zu entdecken und zu erleben, was wir bereits für sie gefunden haben. mit Ihrem einkauf bei uns unterstützen sie direkt handgefertigte kunst von kreativen, aufstrebenden kunsthandwerkern aus aller welt.

mit Ihrem einkauf bei uns
unterstützen sie direkt
handgefertigte kunst von
kreativen, aufstrebenden
kunsthandwerkern weltweit.

alles, was sie sehen, können sie unter www.trobat.co/trobar kaufen.
folgen sie uns unter [@trobat.co](https://www.instagram.com/trobat.co) [@trobar_](https://www.instagram.com/trobar_)

*scan to
shop*



[@trobat.co](https://www.instagram.com/trobat.co)

[@trobar_](https://www.instagram.com/trobar_)